

# Frontier Explorers

Tell It Again!™ Read-Aloud Supplemental Guide

Core Knowledge Language Arts® • Listening & Learning™ Strand



Core Knowledge®

**GRADE 1**

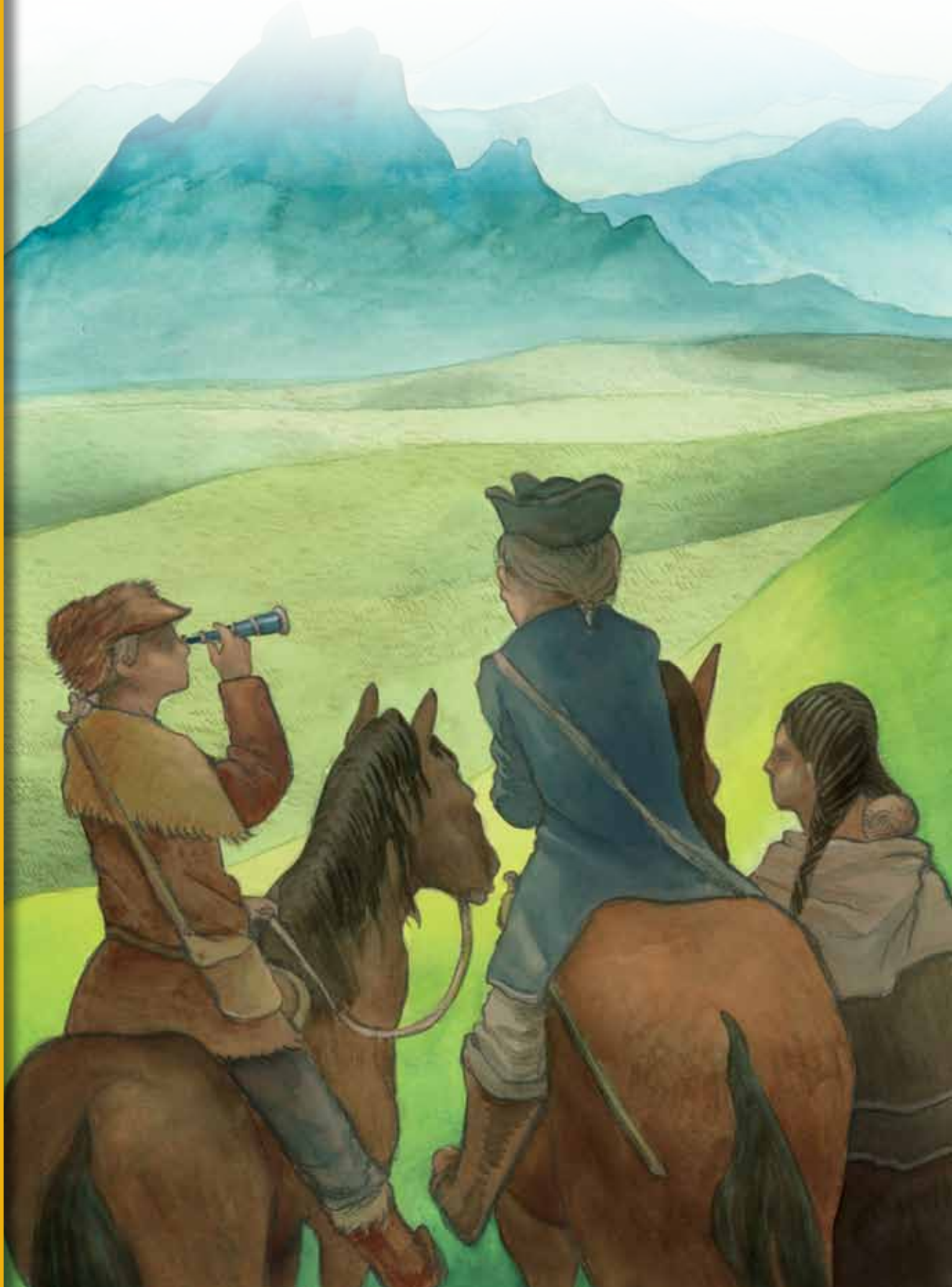



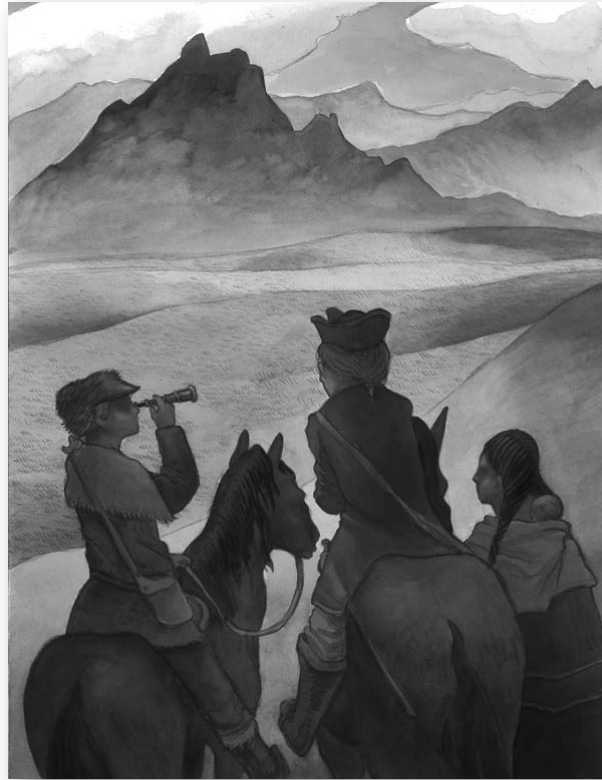

# Frontier Explorers

Transition Supplemental Guide to the  
Tell It Again!<sup>™</sup> Read-Aloud Anthology

Listening & Learning<sup>™</sup> Strand  
GRADE 1

Core Knowledge Language Arts<sup>®</sup>



## Creative Commons Licensing

This work is licensed under a Creative Commons Attribution-NonCommercial-ShareAlike 3.0 Unported License.



You are free:

- to Share** — to copy, distribute and transmit the work
- to Remix** — to adapt the work

**Under the following conditions:**

**Attribution** — You must attribute the work in the following manner:

*This work is based on an original work of the Core Knowledge® Foundation made available through licensing under a Creative Commons Attribution-NonCommercial-ShareAlike 3.0 Unported License. This does not in any way imply that the Core Knowledge Foundation endorses this work.*

**Noncommercial** — You may not use this work for commercial purposes.

**Share Alike** — If you alter, transform, or build upon this work, you may distribute the resulting work only under the same or similar license to this one.

**With the understanding that:**

For any reuse or distribution, you must make clear to others the license terms of this work. The best way to do this is with a link to this web page:

<http://creativecommons.org/licenses/by-nc-sa/3.0/>

Copyright © 2014 Core Knowledge Foundation  
[www.coreknowledge.org](http://www.coreknowledge.org)

All Rights Reserved.

Core Knowledge Language Arts is a trademark  
of the Core Knowledge Foundation.

Trademarks and trade names are shown in this book strictly for illustrative and educational purposes and are the property of their respective owners. References herein should not be regarded as affecting the validity of said trademarks and trade names.

Table of Contents

# Frontier Explorers

Transition Supplemental Guide to the  
Tell It Again!™ Read-Aloud Anthology

<b>Preface</b> to the <i>Transition Supplemental Guide</i> . . . . .	v
<b>Alignment Chart</b> for <i>Frontier Explorers</i> . . . . .	xvii
<b>Introduction</b> to <i>Frontier Explorers</i> . . . . .	1
<b>Lesson 1:</b> Daniel Boone and the Opening of the West . . . . .	14
<b>Lesson 2:</b> Crossing the Appalachian Mountains . . . . .	32
<b>Lesson 3:</b> Jefferson and Monroe . . . . .	50
<b>Lesson 4:</b> The Louisiana Purchase . . . . .	68
<b>Pausing Point</b> . . . . .	87
<b>Lesson 5:</b> Lewis and Clark. . . . .	91
<b>Lesson 6:</b> Lewis and Clark: The Journey Begins . . . . .	106
<b>Lesson 7:</b> Discovery and Danger on the Prairie . . . . .	121
<b>Lesson 8:</b> Sacagawea . . . . .	135
<b>Lesson 9:</b> Red Cedars and Grizzly Bears. . . . .	155
<b>Lesson 10:</b> Rivers and Mountains . . . . .	168
<b>Lesson 11:</b> To the Pacific and Back. . . . .	187
<b>Domain Review</b> . . . . .	202
<b>Domain Assessment</b> . . . . .	205
<b>Culminating Activities</b> . . . . .	208
<b>Appendix</b> . . . . .	211





# Preface to the Transition Supplemental Guide

---

This preface to the *Transition Supplemental Guide* provides information about the guide’s purpose and target audience, and describes how it can be used flexibly in various classroom settings.

**Please note:** The *Supplemental Guides* for the first three domains in Grade 1 contain modified read-alouds and significantly restructured lessons with regard to pacing and activities. These early *Supplemental Guides* provided step-by-step, scaffolded instruction with the intention that students receiving instruction from teachers using the *Supplemental Guide* for the first part of the year would be ready to participate in regular Listening & Learning lessons, and that teachers who have used the *Supplemental Guide* for the first part of the year would be equipped with the instructional strategies to scaffold the lessons when necessary. This shift from the full *Supplemental Guide* to the *Transition Supplemental Guide* affords teachers more autonomy and greater responsibility to adjust their execution of the lessons according to the needs of their classes and individual students.

*Transition Supplemental Guides* for the remaining domains will still contain Vocabulary Charts and *Supplemental Guide* activities such as Multiple Meaning Word Activities, Syntactic Awareness Activities, and Vocabulary Instructional Activities. However, the *Transition Supplemental Guides* do not have rewritten read-alouds and do not adjust the pacing of instruction; the pacing and read-aloud text included in each *Transition Supplemental Guide* is identical to the pacing and read-aloud text in the corresponding *Tell It Again! Read-Aloud Anthology*. We have, however, augmented the introductions and extensions of each lesson in the *Transition Supplemental Guides* so teachers have additional resources for students who need greater English language support. As a result, there are often more activities suggested than can be completed in the allotted time for the introduction or extension activities. Teachers will need to make informed and conscious decisions in light of their particular students’ needs when choosing which activities to complete and which to omit. We strongly recommend that teachers preview the Domain Assessment prior to teaching this domain; this will provide an additional way to inform their activity choices.

## ***Intended Users and Uses***

---

This guide is intended to be used by general education teachers, reading specialists, English as a Second Language (ESL) teachers, special education teachers, and teachers seeking an additional resource for classroom activities. This guide is intended to be both flexible and versatile. Its use is to be determined by teachers in order to fit the unique circumstances and specific needs of their classrooms and individual students. Teachers whose students would benefit from enhanced oral language practice may opt to use the *Transition Supplemental Guide* as their primary guide for Listening & Learning. Teachers may also choose individual activities from the *Transition Supplemental Guide* to augment the content covered in the *Tell It Again! Read-Aloud Anthology*. For example, teachers might use the Vocabulary Instructional Activities, Syntactic Awareness Activities, and modified Extensions during small-group instruction time. Reading specialists and ESL teachers may find that the tiered Vocabulary Charts are a useful starting point in addressing their students' vocabulary learning needs.

The *Transition Supplemental Guide* is designed to allow flexibility with regard to lesson pacing and encourages education professionals to pause and review when necessary. A number of hands-on activities and graphic organizers are included in the lessons to assist students with learning the content.

## ***Transition Supplemental Guide Contents***

---

The *Transition Supplemental Guide* contains tiered Vocabulary Charts, Multiple Meaning Word Activities, Syntactic Awareness Activities, and Vocabulary Instructional Activities. The Domain Assessments and Family Letters have been modified. In some instances, the activities in the Extensions as well as the activities in the Pausing Point, Domain Review, and Culminating Activities have been modified or rewritten. Please refer to the following sample At a Glance Chart to see how additional support is communicated to the teacher.



Exercise	Materials	Details
<b>Introducing the Read-Aloud (10 minutes)</b>		
<b>Introductory Content</b>	[Additional materials to help support this part of the lesson will be listed here.]	[A brief explanation about how the material can be used.]
<b>Vocabulary Preview</b>	[There will be one or two vocabulary preview words per lesson.]	
<b>Purpose for Listening</b>		
<b>Presenting the Read-Aloud (15 minutes)</b>		
<p><b>Note:</b> It is highly recommended that teachers preview the read-aloud, Flip Book images, and comprehension questions to determine when to pause during the read-aloud and ask guiding questions, especially before a central or difficult point is going to be presented (e.g., While we are reading this part of the read-aloud, I want to you think about . . .) and supplementary questions (e.g., Who/What/Where/When/Why literal questions) to check for understanding.</p>		
<b>Title of Read-Aloud</b>	[Materials that may help scaffold the read-aloud will be listed here.]	
<b>Discussing the Read-Aloud (15 minutes)</b>		
<b>Comprehension Questions</b>		
<b>Word Work</b>		
 <b>Complete Remainder of the Lesson Later in the Day</b>		
<b>Extensions (20 minutes)</b>		
<b>Extension Activities</b>	[Additional Extension activities may include a Multiple Meaning Word Activity, a Syntactic Awareness Activity, a Vocabulary Instructional Activity, and modified existing activities or new activities.]	

The additional materials found in the *Transition Supplemental Guide* afford students further opportunities to use domain vocabulary and demonstrate knowledge of content. The lessons of this guide contain activities that create a purposeful and systematic setting for English language learning. The read-aloud for each story or nonfiction text builds upon previously taught vocabulary and ideas and introduces language and knowledge needed for the next more complex text. The *Transition Supplemental Guide's* focus on oral language in the earlier grades addresses the language learning needs of students with limited English

language skills. These students—outside of a school setting—may not be exposed to the kind of academic language found in many written texts.

## Vocabulary Charts

Vocabulary Chart for [Title of Lesson]			
Core Vocabulary words are in <b>bold</b> . Multiple Meaning Word Activity word is <u>underlined</u> . Vocabulary Instructional Activity words have an asterisk (*). Suggested words to pre-teach are in <i>italics</i> .			
Type of Words	Tier 3 Domain-Specific Words	Tier 2 General Academic Words	Tier 1 Everyday-Speech Words
<b>Understanding</b>			
<b>Multiple Meaning</b>			
<b>Phrases</b>			
<b>Cognates</b>			

Vocabulary Charts at the beginning of each lesson categorize words into three tiers which are generally categorized as follows:

- Tier 1 words are words that are likely to appear in the basic repertoire of native English-speaking students—words such as *mountain*, *river*, and *land*.
- Tier 2 words are highly functional and frequently used general academic words that appear across various texts and content areas—words such as *identify*, *purchase*, and *route*.
- Tier 3 words are content-specific and difficult words that are crucial for comprehending the facts and ideas related to a particular subject—words such as *frontier*, *pioneer*, and *prairie*.

English Language Learners and students with limited oral language skills may not necessarily know the meanings of all Tier 1 words, and may find Tier 2 and Tier 3 words confusing and difficult to learn. Thus, explicit explanation of, exposure to, and practice using Tier 1, 2, and 3 words are essential to successful mastery of content for these students (National Governors Association Center for Best Practices, Council of Chief State School Officers 2010 32–35).

In addition, the Vocabulary Chart indicates whether the chosen words are vital to understanding the lesson (labeled *Understanding*); have multiple meanings or senses (labeled *Multiple Meaning*); are clusters of words that often appear together (labeled *Phrases*); or have a Spanish word

that sounds similar and has a similar meaning (labeled *Cognates*). Words in the Vocabulary Chart were selected because they appear frequently in the text of the read-aloud or because they are words and phrases that span multiple grade levels and content areas. Teachers should be aware of and model the use of these words as much as possible before, during, and after each individual lesson. The Vocabulary Chart could also be a good starting point and reference for keeping track of students' oral language development and their retention of domain-related and academic vocabulary. These lists are not meant to be exhaustive, and teachers are encouraged to include additional words they feel would best serve their students.

### **Multiple Meaning Word Activities**

---

Multiple Meaning Word Activities help students determine and clarify the different meanings of individual words. This type of activity supports a deeper knowledge of content-related words and a realization that many content words have multiple meanings associated with them. Students with strong oral language skills may be able to navigate through different meanings of some words without much effort. However, students with limited English language proficiency and minimal vocabulary knowledge may be less likely to disambiguate the meanings of words. This is why it is important that teachers have a way to call students' attention to words in the lesson that have ambiguous meanings, and that students have a chance to explore the nuances of words in contexts within and outside of the lessons.

### **Syntactic Awareness Activities**

---

Syntactic Awareness Activities focus on sentence structure. During the early elementary grades, students are not expected to read or write lengthy sentences, but they might be able to produce complex sentences in spoken language when given adequate prompting and support. Syntactic Awareness Activities support students' awareness of the structure of written language, interrelations between words, and grammar. Developing students' oral language through syntactic awareness provides a solid foundation for written language development in the later elementary grades and beyond.

## Vocabulary Instructional Activities

---

Vocabulary Instructional Activities are included to build students' general academic, or Tier 2, vocabulary. These words are salient because they appear across content areas and in complex written texts. These activities support students' learning of Tier 2 words and deepen their knowledge of academic words and the connections of these words to other words and concepts. The vocabulary knowledge students possess is intricately connected to reading comprehension, the ability to access background knowledge, express ideas, communicate effectively, and learn about new concepts.

## ***English Language Learners and Students with Disabilities***

---

The *Transition Supplemental Guide* assists education professionals who serve students with limited English language skills or students with limited home literacy experience, which may include English Language Learners (ELLs) and students with special needs. Although the use of this guide is not limited to teachers of ELLs and/or students with special needs, the following provides a brief explanation of these learners and the challenges they may face in the classroom, as well as teaching strategies that address those challenges.

### English Language Learners

---

The *Transition Supplemental Guide* is designed to facilitate the academic oral language development necessary for English Language Learners (ELLs) and to strengthen ELLs' understanding of the core content presented in the domains.

When teaching ELLs, it is important to keep in mind that they are a heterogeneous group from a variety of social backgrounds and at different stages in their language development. There may be some ELLs who do not speak any English and have little experience in a formal education setting. There may be some ELLs who seem fluent in conversational English, but do not have the academic language proficiency to participate in classroom discussions about academic content. The following is a chart showing the basic stages of second language acquisition; proper expectations for student behavior and performance; and accommodations and support strategies for each stage. Please note that ELLs may have extensive language skills in their

first language and that they advance to the next stage at various rates depending on their acculturation, motivation, and prior experiences in an education setting.

Language Development Stage	Comprehension and Production	Accommodations and Support Strategies
<b>Entering</b>	<ul style="list-style-type: none"> <li>• Produces little or no English</li> <li>• Responds in nonverbal ways</li> <li>• Has a minimal receptive vocabulary in English</li> </ul>	<ul style="list-style-type: none"> <li>• Use predictable phrases for set routines</li> <li>• Use manipulatives, visuals, realia, props</li> <li>• Use gestures (e.g., point, nod) to indicate comprehension</li> <li>• Use lessons that build receptive and productive vocabulary, using illustrated pre-taught words</li> <li>• Use pre-taught words to complete sentence starters</li> <li>• Use simply stated questions that require simple nonverbal responses (e.g., “Show me . . . ,” “Circle the . . . ”)</li> <li>• Use normal intonation, emphasize key words, and frequent checks for understanding</li> <li>• Model oral language and practice formulaic expressions</li> <li>• Pair with another ELL who is more advanced in oral language skills for activities and discussions focused on the English language</li> <li>• Pair with same-language peers for activities and discussions focused on content</li> </ul>
<b>Emerging (Beginner)</b>	<ul style="list-style-type: none"> <li>• Responds with basic phrases</li> <li>• Includes frequent, long pauses when speaking</li> <li>• Has basic level of English vocabulary (common words and phrases)</li> </ul>	<ul style="list-style-type: none"> <li>• Use repetition, gestures, and visual aids to facilitate comprehension and students’ responses</li> <li>• Use manipulatives, visuals, realia, props</li> <li>• Use small-group activities</li> <li>• Use lessons that expand receptive and expressive vocabulary, especially Tier 2 vocabulary</li> <li>• Use illustrated core vocabulary words</li> <li>• Use pre-identified words to complete cloze sentences</li> <li>• Use increasingly more difficult question types as students’ receptive and expressive language skills improve:               <ul style="list-style-type: none"> <li>• Yes/no questions</li> <li>• Either/or questions</li> <li>• Questions that require short answers</li> <li>• Open-ended questions to encourage expressive responses</li> </ul> </li> <li>• Allow for longer processing time and for participation to be voluntary</li> <li>• Pair with another ELL who is more advanced in oral language skills for activities and discussions focused on the English language</li> <li>• Pair with same-language peers for activities and discussions focused on content</li> </ul>

<b>Transitioning (Intermediate)</b>	<ul style="list-style-type: none"> <li>• Speaks in simple sentences</li> <li>• Uses newly learned words appropriately</li> <li>• With appropriate scaffolding, able to understand and produce narratives</li> <li>• Has a much larger receptive than expressive vocabulary in English</li> </ul>	<ul style="list-style-type: none"> <li>• Use more complex stories and books</li> <li>• Continue to focus on Tier 2 vocabulary</li> <li>• Introduce academic terms (e.g., making predictions and inferences, figurative language)</li> <li>• Use graphic organizers</li> <li>• Use increasingly difficult question types as students' receptive and expressive language skills improve: <ul style="list-style-type: none"> <li>• Questions that require short sentence answers</li> <li>• <i>Why</i> and <i>how</i> questions</li> <li>• Questions that check for literal and abstract comprehension</li> </ul> </li> <li>• Provide some extra time to respond</li> <li>• Pair with high-level English speakers for activities and discussions focused on the English language</li> </ul>
<b>Expanding (Advanced)</b>	<ul style="list-style-type: none"> <li>• Engages in conversations</li> <li>• Produces connected narrative</li> <li>• Shows good comprehension</li> <li>• Has and uses expanded vocabulary in English</li> </ul>	<ul style="list-style-type: none"> <li>• Continue work with academic terms (e.g., making predictions and inferences, figurative language)</li> <li>• Use graphic organizers</li> <li>• Use questions that require opinion, judgment, and explanation</li> <li>• Pair with native English speakers</li> </ul>
<b>Commanding (Proficient)</b>	<ul style="list-style-type: none"> <li>• Uses English that nearly approximates the language of native speakers</li> <li>• Can maintain a two-way conversation</li> <li>• Uses more complex grammatical structures, such as conditionals and complex sentences.</li> <li>• Has and uses an enriched vocabulary in English</li> </ul>	<ul style="list-style-type: none"> <li>• Build high-level/academic language</li> <li>• Expand figurative language (e.g., by using metaphors and idioms)</li> <li>• Use questions that require inference and evaluation</li> <li>• Pair with students who have a variety of skills and language proficiencies</li> </ul>

(Adapted from Hirsch and Wiggins 2009, 362–364; New York Department of Education 2013; Smyk et al. 2013)

## **Students with Disabilities and Students with Special Needs**

---

Students with disabilities (SWDs) have unique learning needs that require accommodations and modifications to the general education curriculum. When using the *Transition Supplemental Guide* with SWDs and students with special needs, it is important to consider instructional accommodations, tools, strategies, and Universal Design for Learning (UDL) Principles, which promote learning for all students through the use of multiple forms of representation, expression, and engagement (Hall, Strangman, and Meyer 2003).

### ***Pacing***

Pacing is the purposeful increase or decrease in the speed of instruction. Educators can break lessons into manageable chunks depending on needs of the class and follow the section with a brief review or discussion. This format of instruction ensures that students are not inundated with information. Additionally, you may want to allow students to move around the room for brief periods during natural transition points. When waiting for students to respond, allow at least three seconds of uninterrupted wait time to increase correctness of responses, response rates, and level of thinking (Stahl 1990).

### ***Goals and Expectations***

Make sure students know the purpose and the desired outcome of each activity. Have students articulate their own learning goals for the lesson. Provide model examples of desired end-products. Use positive verbal praise, self-regulation charts, and redirection to reinforce appropriate ways for students to participate and behave.

### ***Directions***

Provide reminders about classroom rules and routines whenever appropriate. You may assign a partner to help clarify directions. When necessary, model each step of an activity's instructions. Offering explicit directions, procedures, and guidelines for completing tasks can enhance student understanding. For example, large assignments can be delivered in smaller segments to increase comprehension and completion (Franzone 2009).

### ***Instruction Format and Grouping***

Use multiple instruction formats (e.g., small-group instruction, individual work, collaborative learning, and hands-on instruction). Be sure to group students in logical and flexible ways that support learning.

### ***Instructional Strategies***

The following evidence-based strategies can assist students with disabilities in learning content (Scruggs et al. 2010):

- **Mnemonic strategies** are patterns of letters and sounds related to ideas that enhance retention and recall of information. They can be used as a tool to encode information.
- **Spatial organizers** assist student understanding and recall of information using charts, diagrams, graphs, and/or other graphic organizers.
- **Peer mediation**, such as peer tutoring and cooperative learning groups, can assist in assignment completion and enhance collaboration within the classroom.
- **Hands-on learning** offers students opportunities to gain understanding of material by completing experiments and activities that reinforce content.
- **Explicit instruction** utilizes clear and direct teaching using small steps, guided and independent practice, and explicit feedback.
- **Visual strategies** (e.g., picture/written schedules, storymaps, task analyses, etc.) represent content in a concrete manner to increase focus, communication, and expression (Rao and Gagie 2006).

### ***References***

1. Biemiller, Andrew. 2010. *Words Worth Teaching*. Columbus: SRA/McGrawHill.
2. Franzone, Ellen L. 2009. "Overview of Task Analysis." Madison, WI: National Professional Development Center on Autism Spectrum Disorders, Waisman Center, University of Wisconsin.
3. Hall, Tracey, Anne Meyer and Nicole Strangman. 2003. "Differentiated Instruction and Implications for UDL Implementation." National Center on Accessing the General Curriculum.



4. Hirsch, Jr., E. D. and Alice K. Wiggins. 2009. *Core Knowledge Preschool Sequence and Teacher Handbook*. Charlottesville, VA: Core Knowledge Foundation.
5. National Governors Association Center for Best Practices, Council of Chief State School Officers. 2010. "Appendix A," in *Common Core State Standards: English Language Arts Standards*. Washington DC: National Governors Association Center for Best Practices, Council of Chief State School Officers.
6. New York Department of Education. 2013. *New York State Bilingual Common Core Initiative*. Accessed October 8. <http://www.engageny.org/resource/new-york-state-bilingual-common-core-initiative#progressions>.
7. Rao, Shaila M. and Brenda Gagie. 2006. "Learning Through Seeing and Doing: Visual Supports for Children with Autism." *Teaching Exceptional Children* 38 (6): 26–33.
8. Scruggs, Thomas E., Margo A. Mastropieri, Sheri Berkeley, and Janet E. Graetz. 2010. "Do Special Education Interventions Improve Learning of Secondary Content? A Meta-Analysis." *Remedial and Special Education* 31: 437–449.
9. Smyk, Ekaterina, M. Adelaida Restrepo, Joanna S. Gorin, and Shelley Gray. 2013. "Development and Validation of the Spanish-English Language Proficiency Scale (SELPS)." *Language, Speech, and Hearing Services in Schools* 44: 252–65.
10. Stahl, Robert J. 1990. "Using 'Think-Time' Behaviors to Promote Students' Information Processing, Learning, and On-Task Participation: An Instructional Module." Tempe, AZ: Arizona State University.



# Alignment Chart for Frontier Explorers

The following chart contains core content objectives addressed in this domain. It also demonstrates alignment between the Common Core State Standards and corresponding Core Knowledge Language Arts (CKLA) goals.

## Alignment Chart for Frontier Explorers

### Lesson

	1	2	3	4	5	6	7	8	9	10	11
<b>Core Content Objectives</b>											
Locate the Appalachian Mountains on a map	✓	✓									
Recall basic facts about Daniel Boone	✓	✓									
Describe Daniel Boone as a trailblazer		✓									
Identify what the Wilderness Road refers to		✓									
Locate the Mississippi River on a map			✓	✓	✓	✓	✓	✓	✓	✓	✓
Locate the Rocky Mountains on a map			✓	✓	✓	✓	✓	✓	✓	✓	✓
Explain why Thomas Jefferson wanted to purchase New Orleans			✓								
Identify and locate the Louisiana Territory on a map				✓	✓	✓	✓	✓	✓	✓	✓
Explain the significance of the Louisiana Territory and Purchase				✓	✓	✓	✓	✓	✓	✓	✓
Explain the reasons that Lewis and Clark went on their expedition					✓	✓	✓	✓	✓	✓	✓
Explain that there were many, many Native American tribes living in the Louisiana Territory before the Lewis and Clark expedition					✓	✓	✓	✓		✓	✓
Recall basic facts about Lewis and Clark's encounters with Native Americans							✓	✓		✓	✓
Explain why and how Sacagawea helped Lewis and Clark								✓		✓	



**Alignment Chart for  
Frontier Explorers**

**Lesson**

		1	2	3	4	5	6	7	8	9	10	11
<b>STD RI.1.9</b>	Identify basic similarities in and differences between two texts on the same topic (e.g., in illustrations, descriptions, or procedures).											
<b>CKLA Goal(s)</b>	Compare and contrast (orally or in writing) similarities and differences within a single nonfiction/informational read-aloud or between two or more nonfiction/informational read-alouds				✓					✓		
<b>Range of Reading and Level of Text Complexity</b>												
<b>STD RI.1.10</b>	With prompting and support, read informational texts appropriately complex for Grade 1.											
<b>CKLA Goal(s)</b>	Listen to and demonstrate understanding of nonfiction/informational read-alouds of appropriate complexity for Grades 1–3						✓					
<b>Writing Standards: Grade 1</b>												
<b>Text Types and Purposes</b>												
<b>STD W.1.1</b>	Write opinion pieces in which they introduce the topic or name the book they are writing about, state an opinion, supply a reason for the opinion, and provide some sense of closure.											
<b>CKLA Goal(s)</b>	Write opinion pieces in which they introduce the topic or name the book they are writing about, state an opinion, supply a reason for the opinion, and provide some sense of closure					✓		✓				
<b>Production and Distribution of Writing</b>												
<b>STD W.1.5</b>	With guidance and support from adults, focus on a topic, respond to questions and suggestions from peers, and add details to strengthen writing as needed.											
<b>CKLA Goal(s)</b>	With guidance and support from adults, focus on a topic, respond to questions and suggestions from peers, and add details to strengthen writing as needed								✓			
<b>Research to Build and Present Knowledge</b>												
<b>STD W.1.8</b>	With guidance and support from adults, recall information from experiences or gather information from provided sources to answer a question.											
<b>CKLA Goal(s)</b>	Make personal connections (orally or in writing) to events or experiences in a fiction or nonfiction/informational read-aloud, and/or make connections among several read-alouds					✓				✓		✓
	With assistance, categorize and organize facts and information within a given domain to answer questions	✓		✓		✓						

**Alignment Chart for  
Frontier Explorers**

**Lesson**

1	2	3	4	5	6	7	8	9	10	11
---	---	---	---	---	---	---	---	---	----	----

**Speaking and Listening Standards: Grade 1**

**Comprehension and Collaboration**

<b>STD SL.1.1</b>	Participate in collaborative conversations with diverse partners about Grade 1 topics and texts with peers and adults in small and large groups.												
<b>STD SL.1.1a</b>	Follow agreed-upon rules for discussions (e.g., listening to others with care, speaking one at a time about the topics and texts under discussion).												
<b>CKLA Goal(s)</b>	Use agreed-upon rules for group discussion, e.g., look at and listen to the speaker, raise hand to speak, take turns, say “excuse me” or “please,” etc.						<input checked="" type="checkbox"/>						
<b>STD SL.1.1b</b>	Build on others’ talk in conversations by responding to the comments of others through multiple exchanges.												
<b>CKLA Goal(s)</b>	Carry on and participate in a conversation over at least six turns, staying on topic, initiating comments or responding to a partner’s comments, with either an adult or another child of the same age						<input checked="" type="checkbox"/>						
<b>STD SL.1.1c</b>	Ask questions to clear up any confusion about the topics and texts under discussion.												
<b>CKLA Goal(s)</b>	Ask questions to clarify information about the topic in a fiction or nonfiction/ informational read-aloud						<input checked="" type="checkbox"/>						
<b>STD SL.1.2</b>	Ask and answer questions about key details in a text read aloud or information presented orally or through other media.												
<b>CKLA Goal(s)</b>	Ask and answer questions (e.g., <i>who, what, where, when</i> ), orally or in writing, requiring literal recall and understanding of the details, and/or facts of a fiction or nonfiction/informational read-aloud			<input checked="" type="checkbox"/>	<input checked="" type="checkbox"/>			<input checked="" type="checkbox"/>		<input checked="" type="checkbox"/>			<input checked="" type="checkbox"/>

**Presentation of Knowledge and Ideas**

<b>STD SL.1.4</b>	Describe people, places, things, and events with relevant details, expressing ideas and feelings clearly.												
<b>CKLA Goal(s)</b>	Describe people, places, things, and events with relevant details, expressing ideas and feelings clearly	<input checked="" type="checkbox"/>		<input checked="" type="checkbox"/>				<input checked="" type="checkbox"/>					
<b>STD SL.1.5</b>	Add drawings or other visual displays to descriptions when appropriate to clarify ideas, thoughts, and feelings.												
<b>CKLA Goal(s)</b>	Add drawings or other visual displays to oral or written descriptions when appropriate to clarify ideas, thoughts, and feelings						<input checked="" type="checkbox"/>		<input checked="" type="checkbox"/>				
<b>STD SL.1.6</b>	Produce complete sentences when appropriate to task and situation.												
<b>CKLA Goal(s)</b>	Produce complete sentences when appropriate to task and situation						<input checked="" type="checkbox"/>						

**Alignment Chart for  
Frontier Explorers**

**Lesson**

1	2	3	4	5	6	7	8	9	10	11
---	---	---	---	---	---	---	---	---	----	----

**Language Standards: Grade 1**

**Vocabulary Acquisition and Use**

<b>STD L.1.5</b>	With guidance and support from adults, demonstrate understanding of word relationships and nuances in word meanings.												
<b>STD L.1.5a</b>	Sort words into categories (e.g., colors, clothing) to gain a sense of the concepts the categories represent.												
<b>CKLA Goal(s)</b>	Provide examples of common synonyms and antonyms												✓
<b>STD L.1.5c</b>	Identify real-life connections between words and their use (e.g., note places at home that are cozy).												
<b>CKLA Goal(s)</b>	Identify real-life connections between words and their use (e.g., note places at home that are cozy)												✓
<b>STD L.1.6</b>	Use words and phrases acquired through conversations, reading and being read to, and responding to texts, including using frequently occurring conjunctions to signal simple relationships (e.g., <i>because</i> ).												
<b>CKLA Goal(s)</b>	Learn the meaning of common sayings and phrases												✓
<b>CKLA Goal(s)</b>	Use words and phrases acquired through conversations, reading and being read to, and responding to texts, including using frequently occurring conjunctions to signal simple relationships (e.g., <i>because</i> )												✓

**Additional CKLA Goals**

Prior to listening to a read-aloud, identify orally what students have learned about a given topic													✓
Share writing with others	✓					✓	✓	✓	✓	✓			✓
Make predictions (orally or in writing) prior to a read-aloud, based on the title, pictures, and/or text heard thus far, and then compare the actual outcomes to predictions		✓											
Identify new meanings for familiar words and apply them accurately		✓		✓									
Identify declarative, interrogative, and exclamatory sentences orally in response to prompts			✓										
Evaluate and select read-alouds on the basis of personal choice for rereading							✓						

 These goals are addressed in all lessons in this domain. Rather than repeat these goals as lesson objectives throughout the domain, they are designated here as frequently occurring goals.





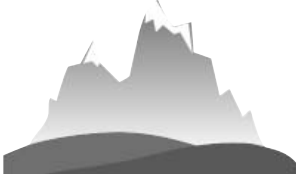

# Frontier Explorers

## Transition Supplemental Guide Introduction

This introduction includes the necessary background information to be used in teaching the *Frontier Explorers* domain. The *Transition Supplemental Guide* for *Frontier Explorers* contains eleven daily lessons, each of which is composed of two distinct parts, so that the lesson may be divided into smaller chunks of time and presented at different intervals during the day. The entire lesson will require a total of sixty minutes.

This domain includes a Pausing Point following Lesson 4. At the end of the domain, a Domain Review, a Domain Assessment, and Culminating Activities are included to allow time to review, reinforce, assess, and remediate content knowledge. **You should spend no more than fifteen days total on this domain.**

Week One									
Day 1	#	Day 2	#	Day 3	#	Day 4	#	Day 5	# ⑩
Lesson 1A: "Daniel Boone and the Opening of the West" (40 min.)		Lesson 2A: "Crossing the Appalachian Mountains" (40 min.)		Lesson 3A: "Jefferson and Monroe" (40 min.)		Lesson 4A: "The Louisiana Purchase" (40 min.)		Pausing Point (60 min.)	
Lesson 1B: Extensions (20 min.)		Lesson 2B: Extensions (20 min.)		Lesson 3B: Extensions (20 min.)		Lesson 4B: Extensions (20 min.)			
60 min.		60 min.		60 min.		60 min.		60 min.	

Week Two									
Day 6	#	Day 7	#	Day 8	#	Day 9	#	Day 10	#
Lesson 5A: "Lewis and Clark" (40 min.)		Lesson 6A: "Lewis and Clark: The Journey Begins" (40 min.)		Lesson 7A: "Discovery and Danger on the Prairie" (40 min.)		Lesson 8A: "Sacagawea" (40 min.)		Lesson 9A: "Red Cedars and Grizzly Bears" (40 min.)	
Lesson 5B: Extensions (20 min.)		Lesson 6B: Extensions (20 min.)		Lesson 7B: Extensions (20 min.)		Lesson 8B: Extensions (20 min.)		Lesson 9B: Extensions (20 min.)	
60 min.		60 min.		60 min.		60 min.		60 min.	

Week Three									
Day 11	#	Day 12	#	Day 13	#	Day 14	⑩	Day 15	#
Lesson 10A: "Rivers and Mountains" (40 min.)		Lesson 11A: "To the Pacific and Back" (40 min.)		Domain Review (60 min.)		Domain Assessment (60 min.)		Culminating Activities (60 min.)	
Lesson 10B: Extensions (20 min.)		Lesson 11B: Extensions (20 min.)							
60 min.		60 min.		60 min.		60 min.		60 min.	

⑩ Lessons include Student Performance Task Assessments.

# Lessons require advance preparation and/or additional materials; please plan ahead.

## Lesson Implementation

---

It is important to note that the interactive activities in the *Transition Supplemental Guide* count on the teacher as the “ideal reader” to lead discussions, model proper language use, and facilitate interactions among student partners.

It is highly recommended that teachers preview the read-aloud, Flip Book images, and comprehension questions to determine when to pause during the read-aloud and ask guiding questions. To check for understanding—especially before a difficult point is to be presented—you might say, “While we are reading this part of the read-aloud, I want you to think about . . .,” or you could ask supplementary questions, such as Who/What/When/Where/Why literal questions.

### Student Grouping

---

Teachers are encouraged to assign partner pairs prior to beginning a domain, and partners should remain together for the duration of the domain. If possible, English Language Learners should be paired with native English speakers, and students who have limited English oral language skills should be paired with students who have strong English language skills. Keep in mind that in some instances beginning English Language Learners would benefit from being in a group of three. Also, pairing an older student or an adult volunteer with a student who has a disability may prove to be an advantage for that student. Partnering in this way promotes a social environment where all students engage in collaborative talk and learn from one another.

In addition, there are various opportunities where students of the same home-language work together, fostering their first-language use and existing knowledge to construct deeper meanings about new information.

### Graphic Organizers and Domain-Wide Activities

---

Several different organizers and domain-wide activities are included to aid students in their learning of the content in the *Frontier Explorers* domain.

- *Frontier Explorers* Map (Instructional Master 1A-1)—This is a student copy of a map of the United States. Students may use this map to follow along with what the teacher is doing on a large class U.S. map. They will see how the United States expanded west. They will also

track the route Lewis and Clark took to the Pacific Ocean. Emphasize the use of cardinal directions, and review key landmarks while working with this map.

- *Frontier Explorers* Timeline—You will create a running class Timeline using Image Cards, which have been provided with this domain. You may wish to have students create their own timeline using Instructional Master 1B-1 and the cutouts on Instructional Master 1B-2.
- *Explorer’s Journal*—The writing project for this domain is a journal. Students will pretend that they are from the time period of this domain as they draw and write about events and discoveries from the read-alouds. Individual journal pages are provided as Instructional Masters in the Appendix.
- Idea Web (Instructional Master 3A-1)—You may wish to fill out an Idea Web to help students describe a person or place. **Note:** Suggested Idea Web topics are provided in the lessons where an Idea Web can be applied.
- The Louisiana Purchase Puzzle (Instructional Master 4B-1)—Use this puzzle to help students visualize and understand that the Louisiana Purchase doubled the size of the United States.
- Tasks Checklist (Instructional Master 5A-1)—The content in the second half of this domain focuses on the expedition of Lewis and Clark and the three tasks that President Jefferson gave them. Use this checklist to remind students of these tasks and to help them keep track of whether the tasks have been accomplished.
- Drama and Music Connections—You may wish to coordinate with the school’s drama teacher to help students act out parts of the read-alouds from this domain. [Suggestions include Monroe visiting Napoleon in France to buy New Orleans from him; Lewis and Clark finding members for the Corps of Discovery; and events and discoveries that happened during Lewis and Clark’s expedition.]  
You may wish to coordinate with the school’s music teacher to practice singing the songs presented in this domain: “On Top of Old Smoky” and “America, the Beautiful.”

## Anchor Focus in Frontier Explorers

---

This chart highlights two Common Core State Standards as well as relevant academic language associated with the activities in this domain.

Anchor Focus	CCSS	Description of Focus and Relevant Academic Language
Writing	W.1.1	<i>Explorer's Journal</i> : Students will draw and write their opinion about the events and discoveries they heard about in the read-alouds. Relevant academic language: <i>journal, record, opinion, reasons</i>
Language	L.1.1j	Produce and expand declarative, interrogative, and exclamatory sentences in response to prompts.

## Domain Components

---

Along with this *Transition Supplemental Guide*, you will need the following:

- *Tell It Again! Media Disk* or the *Tell It Again! Flip Book\** for *Frontier Explorers*
- *Tell It Again! Image Cards* for *Frontier Explorers*

\*The *Tell It Again! Multiple Meaning Word Posters* for *Frontier Explorers* are found at the back of the *Tell It Again! Flip Book*.

Recommended Resource:

- *Core Knowledge Grade 1 Teacher Handbook*, edited by E. D. Hirsch, Jr. and Souzanne A. Wright (Core Knowledge Foundation, 2004) ISBN 978-1890517700

## ***Why Frontier Explorers Are Important***

---

In this domain, students will learn about the American frontier and the explorers that played an important role in the westward expansion of the United States.

While students will hear about many people, events, and dates, it is important to recognize that Grade 1 students are not expected to master or recall all of these details and facts. Some specifics are, of course, necessary so that students can understand and retell the story of the westward expansion of the United States. The details that Grade 1 students should be able to recall are explicitly identified in the Core Content Objectives that follow. Other factual information is incorporated to accurately tell and expose students to the complete “story.” Keep in mind that students in Core Knowledge schools will study this topic further in later grade levels.

Students will first review the development of the thirteen colonies and the Revolutionary War. They will hear how the first English colonists settled along the coast of the Atlantic Ocean. As more people migrated to the colonies, and by the time of the Revolutionary War, the line of the frontier moved all the way to the Appalachian Mountains. Students will learn that the Appalachian Mountains were difficult to traverse and acted as a barrier to the colonists who wanted to settle farther west. Students will be introduced to Daniel Boone and the role he played in westward expansion, specifically his role in the widening of a network of Native American trails that became known as the Wilderness Road.

After hearing about Daniel Boone and the Wilderness Road, students will learn about the presidency of Thomas Jefferson, how Jefferson enabled the purchase of the Louisiana Territory from France, moving the line of the frontier all the way to the Rocky Mountains. Students will hear about Lewis and Clark’s explorations of the Louisiana Territory and about the three reasons why President Jefferson commissioned the exploration of the new land. (to find an all-water route from the Mississippi River to the Pacific Ocean; to make contact with various Native American tribes; and to record the geography and the wildlife of the

Louisiana Territory) Students will also be introduced to Sacagawea and her role in the expedition. By the end of the domain, students should have a good understanding of the concept of westward expansion and how it contributed to the growth of the United States, as well as the key people involved.

Understanding the chronology of events and people in the westward expansion of the United States will lay the foundation for other historical topics, including coverage of 19th-century westward expansion in later grades.

## **What Students Have Already Learned in Core Knowledge Language Arts During Kindergarten**

---

The following domains, and the specific core content that was targeted in those domains, are particularly relevant to the read-alouds students will hear in *Frontier Explorers*. This background knowledge will greatly enhance your students' understanding of the read-alouds they are about to enjoy:

### ***Native Americans***

- Recall that Native Americans were the first inhabitants of North America
- Explain that there are many tribes of Native Americans
- Identify the environment in which the Sioux lived
- Identify the Sioux as a nomadic tribe
- Describe the food, clothing, and shelter of the Sioux
- Explain the importance of the buffalo to the Sioux
- Identify the environment in which the Wampanoag lived
- Explain how the Wampanoag tribe lived
- Identify the Wampanoag as a settled tribe
- Describe the food, clothing, and shelter of the Wampanoag
- Explain that Native Americans still live in the United States today

### ***Kings and Queens***

- Describe what a king or queen does

### ***Columbus and Pilgrims***

- Identify the continents of North America, South America, Europe, Africa, and Asia
- Explain why Europeans wanted to travel to Asia
- Describe the accomplishments of Christopher Columbus
- Recall the year of Columbus’s first voyage to America: 1492
- Explain why Columbus called the land “India” and the inhabitants “Indians”
- Explain why Europeans eventually thought Columbus had discovered a “New World”
- Identify reasons why the Pilgrims left England
- Describe the Pilgrims’ voyage on the Mayflower
- Explain the significance of Plymouth Rock
- Describe the Pilgrims’ first year in America
- Describe the first Thanksgiving Day celebration

### ***Colonial Towns and Townspeople***

- Describe some features of colonial towns, such as a town square, shops, and adjacent buildings

### ***Presidents and American Symbols***

- Describe the differences between a president and a king
- Recognize Thomas Jefferson as the third president of the United States
- Identify Thomas Jefferson as the primary author of the Declaration of Independence
- Describe the purpose of the Declaration of Independence as a statement of America’s liberty

## ***Core Vocabulary for Frontier Explorers***

---

The following list contains all of the core vocabulary words in *Frontier Explorers* in the forms in which they appear in the read-alouds, or in some instances, in the “Introducing the Read-Aloud” section at the beginning of the lesson. The inclusion of the words on this list does not mean that students are immediately expected to be able to use all of these words on their own. However, through repeated exposure throughout the lessons, they should acquire a good understanding of most of these words and begin to use some of them in conversation.

### **Lesson 1**

barrier  
claimed  
settlements  
woodsmen

### **Lesson 2**

passes  
pioneers  
trailblazer  
wilderness

### **Lesson 3**

emperor  
intelligent  
loyal  
mouth

### **Lesson 4**

brilliant  
clever  
mansion  
purchase  
territory

### **Lesson 5**

assistant  
brave  
co-captain

### **Lesson 6**

communicate  
diary  
expedition  
shelters  
survive

### **Lesson 7**

fascinated  
guided  
honored  
prairie

### **Lesson 8**

permanent  
plunged  
protection  
skilled  
translate

### **Lesson 9**

hibernated  
journals  
overturned  
record  
toppled

### **Lesson 10**

confidently  
dull  
sign language  
waterfall

### **Lesson 11**

canyons  
communities  
contentment  
current  
steered



In addition to this core vocabulary list, every lesson includes its own Vocabulary Chart. Words in this chart either appear several times in the Read-Aloud or are words and phrases that support broader language growth, which is crucial to the English language development of young students. Most words on the chart are part of the General Service list of the 2000 most common English words or part of the Dale-Chall list of 3000 words commonly known by Grade 4. Moreover, a conscious effort has been made to include words from the Primary Priority Words according to Biemiller’s (2010) *Words Worth Teaching*. The words on the Vocabulary Chart are not meant to be exhaustive, and teachers are encouraged to add additional words they feel would best serve their group of students.

<b>Vocabulary Chart for Crossing the Appalachian Mountains</b>			
Core Vocabulary words are in <b>bold</b> . Multiple Meaning Word Activity word is <u>underlined</u> . Vocabulary Instructional Activity words have an asterisk (*). Suggested words to pre-teach are in <i>italics</i> .			
<b>Type of Words</b>	<b>Tier 3</b> Domain-Specific Words	<b>Tier 2</b> General Academic Words	<b>Tier 1</b> Everyday-Speech Words
<b>Understanding</b>	footpath fort Kentucky settler <b>wilderness</b> woodsman	delighted desire fertile identify*	family forest friend hunted mountain road
<b>Multiple Meaning</b>	gaps <b>pioneer*</b> trail <b>trailblazer</b>	<u>pass</u> <b>passes</b> rich	land
<b>Phrases</b>	Appalachian Mountains Cumberland Gap Daniel Boone John Finley Native Americans the pioneering spirit the West Wilderness Road	on the lookout the other side	
<b>Cognates</b>	fuerte <b>pionero(a)*</b>	deleitado deseo fértil identificar* <u>paso</u>	familia foresta montaña

## References

1. Beck, Isabel L., Margaret G. McKeown, and Linda Kucan. 2008. *Creating Robust Vocabulary: Frequently Asked Questions and Extended Examples*. New York: Guilford.
2. Biemiller, Andrew. 2010. *Words Worth Teaching*. Columbus, OH: SRA/McGrawHill.
3. Dale, Edgar, and Jeanne Chall. 1995. *Readability Revisited: The New Dale-Chall Readability Formula*.
4. West, Michael. 1953. *A General Service List of English Words*. London: Longman, Green and Co.

## Comprehension Questions

---

In the *Frontier Explorers* domain, there are three types of comprehension questions.

*Literal* questions assess students' recall of key details from the read-aloud; these questions are text dependent, requiring students to paraphrase and/or refer back to the portion of the read-aloud in which the specific answer to the question is provided. These questions generally address Reading Standards for Literature 1 (RL.1.1) and Reading Standards for Informational Text 1 (RI.1.1).

*Inferential* questions ask students to infer information from the text and think critically; these questions are also text dependent, but require students to paraphrase and/or refer back to the different portions of the read-aloud that provide information leading to and supporting the inference they are making. These questions generally address Reading Standards for Literature 2–4 (RL.1.2–RL.1.4) and Reading Standards for Informational Text 2–4 (RI.1.2–RI.1.4).

*Evaluative* questions ask students to build upon what they have learned from the text using analytical and application skills; these questions are also text dependent, but require students to paraphrase and/or refer back to the portion(s) of the read-aloud that substantiate the argument they are making or the opinion they are offering. *Evaluative* questions might ask students to describe how reasons or facts support specific points in a read-aloud, which addresses Reading Standards for Informational Text 8 (RI.1.8). *Evaluative* questions might also ask students

to compare and contrast information presented within a read-aloud or between two or more read-alouds, addressing Reading Standards for Literature 9 (RL.1.9) and Reading Standards for Informational Text 9 (RI.1.9).

The *Supplemental Guides* include complex texts, thus preparing students in these early years for the increased vocabulary and syntax demands that aligned texts will present in later grades. As all of the readings incorporate a variety of illustrations, Reading Standards for Literature 7 (RL.1.7) and Reading Standards for Informational Text 7 (RI.1.7) are addressed as well.

## ***Student Performance Task Assessments***

---

In the *Transition Supplemental Guide for Frontier Explorers*, there are numerous opportunities to assess students' learning. These assessment opportunities range from informal observations, such as *Think Pair Share* and some *Extension* activities, to more formal written assessments. These Student Performance Task Assessments (SPTAs) are identified with this icon: . There is also an end-of-domain summative assessment. Use the Tens Conversion Chart located in the Appendix to convert a raw score on each SPTA into a Tens score. On the same page, you will also find the rubric for recording observational Tens scores.

## ***Above and Beyond***

---

In the *Transition Supplemental Guide for Frontier Explorers*, there are numerous opportunities in the lessons and Pausing Points to challenge students who are ready to attempt activities that are above grade level. These activities are labeled “Above and Beyond” and are identified with this icon: .

## ***Supplemental Guide Activities***

---

The *Supplemental Guide* activities that may be particularly relevant to any classroom are the Multiple Meaning Word Activities and accompanying Multiple Meaning Word Posters; Syntactic Awareness Activities; and Vocabulary Instructional Activities. Several multiple meaning words in the read-alouds are underlined to indicate that there is a Multiple Meaning

Word Activity associated with them. These activities afford all students additional opportunities to acquire a richer understanding of the English language. *Supplemental Guide* activities are identified with this icon: ↔

## ***Recommended Resources for Frontier Explorers***

---

### **Trade Book List**

---

The *Transition Supplemental Guide* for *Frontier Explorers* includes a number of opportunities in Extensions, the Pausing Point, and the Culminating Activities for teachers to select trade books from the list below to reinforce domain concepts through the use of authentic literature. In addition, teachers should consider other times throughout the day when they might infuse authentic domain-related literature.

If you recommend that families read aloud with their child each night, you may wish to suggest that they choose titles from this trade book list to reinforce the domain concepts. You might also consider creating a classroom lending library, allowing students to borrow domain-related books to read at home with their families.

1. *Bewildered for Three Days As to Why Daniel Boone Never Wore His Coonskin Cap*, by Andrew Glass (Holiday House, 2000) ISBN 978-0823414468\*
2. *Exploring the West*, edited by E. D. Hirsch, Jr. (Pearson Learning, 2002) ISBN 978-0769050119
3. *Ghost Town at Sundown (Magic Tree House, #10)*, by Mary Pope Osborne (Random House Books for Young Readers, 1997) ISBN 978-0679883395
4. *I Am: Sacagawea*, by Grace Norwich and illustrated by Anthony Vanarsdale (Scholastic Paperbacks, 2012) ISBN 978-0545405744
5. *The Legend of Daniel Boone*, by Eric Blair and illustrated by Micah Chambers-Goldberg (Picture Window Books, 2005) ISBN 978-1404809741
6. *Lewis and Clark*, by Lisa Wade McCormick (Scholastic Inc., 2006) ISBN 978-0516214436

7. *Lewis and Clark: A Prairie Dog for the President*, by Shirley Raye Redmond (Random House, 2003) ISBN 978-0375811203
8. *Lewis and Clark: Explorers of the American West*, by Steven Kroll (Holiday House, 1996) ISBN 978-0823412730
9. *Lewis and Clark for Kids: Their Journey of Discovery with 21 Activities*, by Janis Herbert (Chicago Review Press, 2000) ISBN 978-1556523748
10. *The Mississippi River*, by Allan Fowler (Children's Press, 2000) ISBN 978-0516265568
11. *A Picture Book of Davy Crockett*, by David A. Adler and illustrated by John and Alexandra Wallner (Holiday House, 1996) ISBN 978-0823412129
12. *A Picture Book of Sacagawea*, by David A. Adler and illustrated by Dan Brown (Holiday House, 2000) ISBN 978-0823414857
13. *Postcards from William*, by Betty Southard Stokes and illustrated by Emry Quinn (Harmony House Publishers, 2006) ISBN 978-1564692023
14. *Sacagawea*, by Jan Gleiter and Kathleen Thompson and illustrated by Yoshi Miyake (Raintree/Steck-Vaughn, 1998) ISBN 978-0817268893
15. *Seaman's Journal: On the Trail with Lewis and Clark*, by Patricia Reeder Eubank (Ideals Children's Books, 2002) ISBN 978-0824954420
16. *Who Was Daniel Boone?*, by Sydelle Kramer and illustrated by George Ulrich (Grosset and Dunlap, 2006) ISBN 978-0448439020

\*This book may be better for one-on-one reading.

## Websites and Other Resources

---

### Teacher Resources

1. Lewis and Clark  
<http://www.archives.gov/education/lessons/lewis-clark/>
2. Louisiana Purchase  
[http://www.learner.org/interactives/historymap/states\\_louisiana.html](http://www.learner.org/interactives/historymap/states_louisiana.html)
3. Thomas Jefferson and the Louisiana Purchase  
<http://www.loc.gov/exhibits/jefferson/jeffwest.html>



# Daniel Boone and the Opening of the West

1

## ✓ Lesson Objectives

---

### Core Content Objectives:

---

Students will:

- ✓ Locate the Appalachian Mountains on a map
- ✓ Recall basic facts about Daniel Boone

### Language Arts Objectives

---

The following language arts objectives are addressed in this lesson. Objectives aligning with the Common Core State Standards are noted with the corresponding standard in parentheses. Refer to the Alignment Chart for additional standards addressed in all lessons in this domain.

Students will:

- ✓ Describe the connection between the Appalachian Mountains and the settlers' inability to move west (RI.1.3)
- ✓ With assistance, create and interpret a timeline of the settlement of North America (W.1.8)
- ✓ Describe how a woodsman survives with relevant details, expressing ideas and feelings clearly (SL.1.4)
- ✓ Share writing with others

### Core Vocabulary

---

**barrier, n.** Something that separates or blocks you from going from one place to another

*Example:* The Appalachian Mountains were a natural barrier to moving west.

*Variation(s):* barriers

**claimed, v.** To say something belongs to you, even if others might not agree

*Example:* Thomas claimed that the basketball was his, even though it did not have his name written on it.

*Variation(s):* claim, claims, claiming

**settlements, n.** Places where people make their homes, often in new areas

*Example:* Some families decided to leave their homes in Europe and move to the settlements in America.

*Variation(s):* settlement

**woodsmen, n.** People who live or work in the forest

*Example:* The woodsmen were able to build shelters out of tree branches.

*Variation(s):* woodsman

Vocabulary Chart for Daniel Boone and the Opening of the West			
Core Vocabulary words are in <b>bold</b> .			
Multiple Meaning Word Activity word is <u>underlined</u> .			
Vocabulary Instructional Activity words have an asterisk (*).			
Suggested words to pre-teach are in <i>italics</i> .			
Type of Words	Tier 3 Domain-Specific Words	Tier 2 General Academic Words	Tier 1 Everyday-Speech Words
<b>Understanding</b>	continent Europe/Europeans explorer <i>frontier</i> rifle <i>settlers</i> tomahawk <b>woodsmen</b>	adventuresome <b>barrier*</b> <b>claimed</b> content curious interested survive	father forest knife map paths mountains west woods
<b>Multiple Meaning</b>	<b>settlements</b>	help hunt	cross farm fights land <u>spoke</u>
<b>Phrases</b>	Appalachian Mountains Daniel Boone Native American North America United States	the best shot for miles around vital skills	
<b>Cognates</b>	continente Europa/europeo(a) <i>frontera</i>	<b>barrera*</b> curioso(a) interesado(a) sobrevivir	foresta mapa montaña oeste

**Note:** Introducing the Read-Aloud and Extensions may have activity options that exceed the time allocated for that part of the lesson. To remain within the time periods allocated for each portion of the lesson, you will need to make conscious choices about which activities to include based on the needs of your students.

Exercise	Materials	Details
<b>Introducing the Read-Aloud (10 minutes)</b>		
<b>Domain Introduction</b>	Instructional Master 1A-1 (Frontier Explorers Map); U.S. Map	Give each student their own copy of a Frontier Explorers Map. Students can use their own maps to follow along as the teacher refers to a class U.S. map.
	stacking blocks	Use stacking blocks to show the progression from individual to city/town, state, country, and continent.
<b>Timeline</b>	Image Cards 1–4; chart paper, chalkboard, whiteboard; world map or globe	Use the timeline to review what students have learned in the Kindergarten and Grade 1 Core Knowledge Language Arts program.
<b>Vocabulary Preview: Frontier, Settlers</b>	images of American frontier landscapes; U.S. map	
	Image 1A-5	
<b>Purpose for Listening</b>	Image 1A-7	Show students a portrait of Daniel Boone. Tell them that they will hear about Daniel Boone’s childhood and his curiosity about life in the woods.
<b>Presenting the Read-Aloud (15 minutes)</b>		
<b>Daniel Boone and the Opening of the West</b>	U.S. map; images of items in the read-aloud	Use images of items mentioned in the read-aloud to help students understand that Daniel Boone was a good hunter.
	chart paper, writing tools	List descriptions of Daniel Boone. Use this list to answer Comprehension Question #4.
<b>Discussing the Read-Aloud (15 minutes)</b>		
<b>Comprehension Questions</b>		
<b>Word Work: Barrier</b>	Image 1A-8	
 <b>Complete Remainder of the Lesson Later in the Day</b>		



Exercise	Materials	Details
<b>Extensions (20 minutes)</b>		
<b>Multiple Meaning Word Activity: Spoke</b>	Poster 1M (Spoke)	
<b>Timeline</b>	Image Card 5; timeline	Add Daniel Boone to the timeline. Stress that his childhood took place before the Declaration of Independence was signed.
	Instructional Masters 1B-1 (Timeline) and 1B-2 (Image Sheet)	Have students make individual timelines that match the class's timeline.
<b>The Appalachian Mountains</b>	Frontier Explorers Map; orange and brown crayons or markers	
<b>Explorer's Journal #1</b>	Instructional Master 1B-3	
<b>Take-Home Material</b>		
<b>Family Letter</b>	Instructional Masters 1B-4–6	

### **Advance Preparation**

Make a copy of Instructional Master 1A-1 for each student. Refer to it as their *Frontier Explorer* Map. Students will be coloring in this map throughout this domain.

Prepare a large class timeline that is long enough to fit nine Image Cards, using Instructional Master 1B-1 as a guide.

For Vocabulary Preview, find images of American frontier landscapes for students to view what the frontier looked like.

For Presenting the Read-Aloud, find images mentioned in the read-aloud (e.g., hunting knife, tomahawk, rifle, wild turkey, and deer) to help students understand that Daniel Boone was a good hunter. In addition, make a list of descriptions of Daniel Boone.

Make copies of Instructional Masters 1B-1 and 1B-2 for each student. Students will create individual timelines to keep track of information they hear in this domain.

Make a copy of Instructional Master 1B-3 for each student. This will be the first page of the students' Explorer's Journal. They will draw what they think the American frontier might have looked like to Daniel Boone and write their opinion about whether getting to the frontier would be easy or difficult for Daniel Boone.

### **Notes to Teacher**

Students who participated in the Kindergarten Core Knowledge Language Arts program should have learned about Native Americans, Columbus, and the Pilgrims. Students have learned about the Declaration of Independence and the American Revolution in the *A New Nation: American Independence* domain. You may need to spend more time building background information for students who are new to the CKLA program.

The concepts of the *frontier* and the *West* (or *American West*) may be confusing because its boundaries shifted west and southwest as the nation grew, but not in an orderly progression. Using a map of the United States, explain that the United States began as the thirteen original colonies along the east coast. Tell students that they will learn about how the United States grew and how European settlers began to move west and make settlements in the west. Define the frontier as the land beyond where there were settlements. Explain that the location of the frontier shifted as the nation's boundaries moved west and southwest, and as the European settlers began to explore and settle on the land. It is important to note that long before the European settlers came to North America, Native Americans had already been living in North America for thousands of years. As European settlements began to grow, Native Americans were forced off the land on which they had been living and moved west.

On the class map, you may wish to initially cover up the western part of the United States—beyond the Appalachian Mountains—then progressively uncover other areas of the country as they are mentioned in the lessons.

**Reference Note:** For your personal reference, note that in the early days of European colonization of the present-day United States, English colonists and others settled along the Atlantic coastline. By the time of the American Revolutionary War, the “line” representing the frontier was effectively represented by the Appalachian Mountains. After the war, American colonists began crossing those mountains in greater numbers, moving west towards the shores of the Mississippi River and settling the areas we know today as the states of Ohio, Indiana, Illinois, Michigan, Wisconsin, Tennessee, Kentucky, Alabama, and Mississippi.



# Daniel Boone and the Opening of the West

1A

**Note:** Introducing the Read-Aloud may have activity options that exceed the time allocated for this part of the lesson. To remain within the time periods allocated for this portion of the lesson, you will need to make conscious choices about which activities to include based on the needs of your students.

## Introducing the Read-Aloud

10 minutes

### Domain Introduction

5 minutes

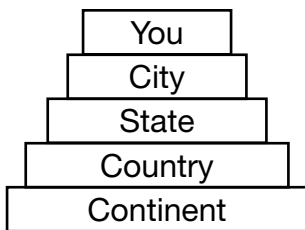

Review with students details about where they live. Point to the appropriate location on a U.S. map as you review the following:

- You live in (your city).
- (Your city) is in (your state).
- (Your state) is the country of the United States of America.

Explain to students that there has not always been a country known as the United States of America. Remind students that Native Americans were the first known people to live in North America, and that European settlers did not originally live in North America. Tell them that long ago the United States was much smaller than it is today. Explain to students that for a time, European settlers only lived on the east coast of what is now the United States. Point to the east coast area of the United States, from the Appalachian Mountains to the Atlantic Ocean.

Tell them that for the next several days they will be learning about how the United States grew in size and how this growth affected Native Americans, settlers, and the landscape.

### Timeline

10 minutes

**Note:** The intent of this first lesson is to review information that students have previously learned in the Core Knowledge Language Arts program. This knowledge provides the foundation

for subsequent lessons in this domain. In the timeline activity, students are asked to recall what they may have learned in Kindergarten about Native Americans, Columbus, and the Pilgrims. In this activity, it is not necessary to provide an exhaustive review of each of these topics. Rather, the purpose is to orient students to the topics that will be addressed in the read-aloud.

Create a timeline similar to the one shown below on a large piece of chart paper, a chalkboard, or a whiteboard.



Remind students that in the Kindergarten Core Knowledge Language Arts program, they learned about the very first people who lived in North America, the Native Americans. Tell students that you are going to place an Image Card of Native Americans (Image Card 1) at the left end of the timeline to help them remember that Native Americans were the first people known to live in North America. Ask students to share what they remember about Native Americans.

Next, remind students that in Kindergarten they also learned about a European explorer named Columbus who traveled by ship to the continent of North America. Use a world map or globe to point out Europe and the general transatlantic route taken by Columbus sailing to North America. Ask students to share what they remember about Columbus's travels. Tell them that you are going to place an Image Card of Columbus (Image Card 2) on the timeline to show that he came to North America after the Native Americans had been living there for many, many years.

Now explain to students that after Columbus's voyages, more and more groups of people from various countries in Europe decided to make the trip across the Atlantic Ocean to explore North America. Remind students that one of these groups was the Pilgrims who came from England and landed at Plymouth Rock, along the east coast of North America. Use a world map or globe to point out the approximate location of the Pilgrims' landing in Massachusetts. Ask students to share what they remember about

the Pilgrims. Tell students that you are going to place an Image Card of Pilgrims (Image Card 3) on the timeline to show that the Pilgrims came to America after Columbus.

Review with students that, as they learned in *A New Nation: American Independence*, more and more people came over from Europe after Columbus and formed colonies. Remind students that before the United States became a country, there were thirteen colonies that were ruled by the British king and government. These colonies displaced many of the Native Americans already living in the area, and forced them to leave their homes and move west. Remind students that the thirteen colonies decided they wanted to declare themselves a free and independent nation and that Thomas Jefferson was asked to write the Declaration of Independence. Tell students that you are going to place an Image Card of the Declaration of Independence (Image Card 4) on the timeline to remind them that the colonists declared independence from Great Britain, which resulted in the Revolutionary War.

## Vocabulary Preview

5 minutes

### *Frontier*

1. The title of this domain is called *Frontier Explorers*. It is about the opening up and exploration of the American *frontier*.
2. Say the word *frontier* with me three times.
3. A frontier is a place that is beyond where there are settlements in which people live. A frontier is a place that is largely unknown and unexplored.
4. At the time of today's read-aloud, the frontier is the land beyond the thirteen original colonies.  
[Point to the area of the thirteen colonies. Tell students that this area had settlements with many people living in them. Point to the area west of the thirteen colonies. Tell students that at that time, this was the frontier.]  
European settlers became curious about what the frontier was like.
5. [Show images of American frontier landscapes.] Look at these pictures, and tell your partner what the frontier looked like.

What kinds of things do you see? (large fields; mountains; streams; buffalo; homes spread apart)  
How is the frontier different from a city?



### **Settlers**

← **Show image 1A-5: Native Americans helping settlers survive**

1. In today's read-aloud you will hear that the Native Americans helped the *settlers* from Europe survive their first winter in North America, but later the *settlers* claimed for themselves the land where the Native Americans had lived.
2. Say the word *settlers* with me three times.
3. Settlers are people who move to a new area to live there.
4. The settlers had to leave many things behind as they moved to a new land.  
After living along the eastern coast for a while, some settlers became interested in moving west.
5. Who lived in North America before the settlers came? (Native Americans)  
Tell your partner how you would have felt if you were a Native American who was forced to leave your home because settlers came.

### **Purpose for Listening**

---

Explain to students that in today's read-aloud, they will briefly review what they have already learned about the early history of the United States and the people who lived there. Tell them that they will also hear about one of the first explorers of the American West, Daniel Boone. Tell students to listen carefully to find out about one of the difficulties or challenges faced by Daniel Boone and other people who wanted to move west.



## Daniel Boone and the Opening of the West

### ← Show image 1A-1: Map of North America with country and state lines

1 [Point to North America as you talk about it, emphasizing that the Atlantic Ocean is to the east and the Pacific Ocean is to the west.]

Today, people from all over the world live together in communities from one end of the North American continent to the other—from the Atlantic Ocean in the east, to the Pacific Ocean in the west, and everywhere in between.<sup>1</sup> This map of North America shows the United States in green. You can see lots of thin white lines outlining the states that make up our country, the United States of America. However, hundreds of years ago the map of the United States was much smaller than it is today.



### ← Show image 1A-2: Native Americans

Long, long ago, the only people who lived on the continent of North America were people known as Native Americans. Native Americans have lived in North America for thousands of years. Native Americans lived in both seasonal and permanent villages. They used great knowledge of the land and its resources to survive.



### ← Show image 1A-3: World map

2 [Point to Europe as you talk about it.]

3 [Point to North America again, and ask students if they can name one of the first European explorers to visit North America.]

At the same time, far away on the other side of the ocean, many other people had their own towns and villages. These people lived on the continent of Europe and were known as Europeans.<sup>2</sup> About six hundred years ago, Europeans began to leave their lands and sail to other parts of the world, seeking spices, gold, and other riches. Some of these explorers arrived in North America.<sup>3</sup>



### ← Show image 1A-4: Europeans and Native Americans

Imagine how surprised Native Americans and Europeans must have been to see each other: people who looked, dressed, and spoke very differently from themselves.<sup>4</sup>

4 Here, the word *spoke* means talked. The word *spoke* also means one of the bars that connect the center of a wheel to its rim, like in a wagon wheel or bicycle wheel.

The early explorers who came to North America were mostly interested in finding goods and riches that they could take back to Europe to sell. Many of these explorers learned vital skills from the

5 Vital skills are crucial or extremely important to someone's survival.

6 [Have students trace the paths of trading ships across the Atlantic Ocean on the map or in the air with their fingers.]



7 Settlements are places where people make their homes in a new land.

8 [Show students the approximate locations of Plymouth and Jamestown on a U.S. map.]



9 The word *claimed* means that the English said the land belonged to them, even though the Native Americans have been living on that land for thousands of years.

10 [Help students locate the east coast, from Massachusetts to Georgia, on a map.]

Native Americans.<sup>5</sup> The Native Americans knew the land very well. They taught the Europeans many skills, including hunting, fishing, gathering, and farming. In exchange for their help, Europeans brought things to trade with the Native Americans, such as cloth. For many years Europeans traveled back and forth across the Atlantic Ocean.<sup>6</sup>

← **Show image 1A-5: Native Americans helping settlers survive**

Most Europeans were content to just trade with the Native Americans, but others became interested in starting **settlements**, because they wanted to live on the continent as well.<sup>7</sup> The English started two early settlements in North America in the 1600s—Plymouth, in what is now Massachusetts, and Jamestown, in what is now Virginia.<sup>8</sup> At first, the Native Americans helped them survive. Do you remember how at Plymouth they celebrated their harvest together, the first Thanksgiving in America? The Europeans would not have been able to grow the corn and squash for that meal without help from the Native Americans.

← **Show image 1A-6: English settlements and Native American communities**

As time passed, more and more Europeans arrived to start settlements in North America, even though Native Americans had already been living in their own communities on that same land. Fights over the land began to erupt, as each group refused to share the land. The settlers **claimed** most of the land on the east coast of North America—land where the Native Americans had lived for many years.<sup>9</sup> The British formed colonies, or settlements ruled by far-away Great Britain, from Massachusetts all the way to Georgia.<sup>10</sup>

Eventually, some of the more adventuresome settlers wanted to explore land to the west of them. One of these people was a young man by the name of Daniel Boone.





← **Show image 1A-7: Portrait of Daniel Boone**

11 [Point to the state of Pennsylvania on a map, and emphasize that it is on the East Coast.]

Daniel Boone was born in 1734 near the town of Reading, Pennsylvania.<sup>11</sup> His father and mother owned a farm. Daniel and his brothers and sisters all helped their parents plow the fields on the farm. But Daniel was never content in the open fields. He was curious about life in the woods around their farm and spent as much time as possible creating paths through the forest. He made friends with young Native American boys who lived in the wooded areas. They taught Daniel how to move silently through the forest and how to trap wild animals and catch fish in the streams. Daniel learned how to use a knife and tomahawk at an early age. His father, seeing how interested Daniel was in hunting, taught Daniel how to use a special type of gun called a rifle.<sup>12</sup>

12 It was common for people to learn hunting and survival skills during this time in history, which is very different from today. Today, most people have the option to buy food and clothing rather than hunting for these resources themselves.

One day, while helping his father plow the fields, Daniel asked if he could be allowed to help out the family in another way. “Father,” he said, “since you taught me to shoot a rifle, I have practiced and practiced until I am the best shot for miles around. Let me hunt for food for our family.” Daniel’s father agreed, and soon the Boones were feasting on wild turkey and deer.

13 [Point to the state of North Carolina on a map, and emphasize that it is on the East Coast.]

In 1750, just before Daniel turned sixteen, the Boone family moved from Pennsylvania to the Yadkin River Valley of North Carolina, settling at the edge of the frontier.<sup>13</sup> It did not take long for the other settlers in his new home to discover that Daniel was one of the best **woodsmen** for miles around.<sup>14</sup> Daniel began to explore his new surroundings. His explorations took him deep into the forests. He heard tales of buffalo to the west and wanted to try hunting other animals than the plentiful deer and bear that lived in the woods nearby. But Daniel was unable to go as far west as he wanted to go. Something was stopping him and other settlers from travelling farther west. Can you guess what it was?<sup>15</sup>

14 Woodsmen are people who live or work in the forest. Daniel Boone lived and worked in the forest.

15 [Pause for students to respond.]



← **Show image 1A-8: U.S. map with Appalachian Mountains highlighted**

There were enormous mountains standing in his way! These mountains are called the Appalachian Mountains, and they

stretch for miles, from the present-day state of Maine all the way to Georgia. The mountains were heavily wooded, making them difficult to cross. They formed a natural **barrier**, and blocked movement from one side of the mountains to the other. For this reason, few European settlers had left their colonies along the eastern coast of North America to travel west. But Daniel knew that Native Americans had crisscrossed these mountains for years. As he roamed through the densely forested hillsides, his curiosity about lands to the west grew stronger. Daniel began to ask everyone he met if they knew of a way to cross the mountains.

## Discussing the Read-Aloud

15 minutes

### Comprehension Questions

10 minutes

If students have difficulty responding to questions, reread pertinent passages of the read-aloud and/or refer to specific images. If students give one-word answers and/or fail to use read-aloud or domain vocabulary in their responses, acknowledge correct responses by expanding students' responses using richer and more complex language. Ask students to answer in complete sentences by asking them to restate the question in their responses.



← **Show image 1A-8: U.S. map with the Appalachian Mountains highlighted**

[Point out the eastern United States where the Europeans first settled.]

1. *Inferential* Where did Daniel Boone want to go? (Daniel Boone wanted to go west.) Why did Daniel Boone and other English settlers want to go west? (Daniel Boone wanted to go west so he could explore and find new places to live.)
2. *Literal* Which civilization of people had been living in North America for a long time before the European settlers came? (Native Americans)
3. *Literal* What kept the English settlers from moving farther west across North America? (The mountains kept the English settlers from moving farther west across North America.)

4. *Literal* Point to the mountains in this picture. (Students should point to the Appalachian Mountains, the highlighted portion of the map.) What are the mountains called? (The mountains in the picture are called the Appalachian Mountains.)
5. *Inferential* How would you describe Daniel Boone? (Daniel Boone was a good hunter and woodsman who was curious about how to travel west across the Appalachian Mountains.)
6. *Evaluative* Do you think that Daniel Boone will find a way over the mountains? (Answers may vary.)

[Please continue to model the *Think Pair Share* process for students, as necessary, and scaffold students in their use of the process.]

I am going to ask a question. I will give you a minute to think about the question, and then I will ask you to turn to your neighbor and discuss the question. Finally, I will call on several of you to share what you discussed with your partner.

6. *Evaluative Think Pair Share:* The title of today’s read-aloud was “Daniel Boone and the Opening of the West.” What do you think the title might mean? (Daniel Boone is looking for a way over the Appalachian Mountains to open the west to settlement, etc.)
7. After hearing today’s read-aloud and questions and answers, do you have any remaining questions? [If time permits, you may wish to allow for individual, group, or class research of the text and/or other resources to answer these questions.]



### Word Work: Barrier

5 minutes

#### ← Show image 1A-8: U.S. map with Appalachian Mountains highlighted

1. In the read-aloud you heard, “[The Appalachian Mountains] formed a natural *barrier*.”
2. Say the word *barrier* with me.
3. A barrier is something that separates or blocks you from getting from one place to another place.

4. The Atlantic Ocean was a great barrier between England and the colonies.  
The Appalachian Mountains were a barrier that blocked settlers from moving west.
5. Look at this map. Why were the Appalachian Mountains a barrier that blocked settlers from moving west?  
[Ask two or three students. If necessary, guide and/or rephrase students' responses: "The Appalachian Mountains were a barrier that blocked settlers from moving west because . . ."]
6. What's the word we've been talking about?  
Use a *Making Choices* activity for follow-up. Directions: I am going to name some things. If what I name is an example of a barrier, say, "That is a barrier." If what I name is not an example of a barrier, say, "That is not a barrier."
  - mountains separating the east and the west of a country (That is a barrier.)
  - a sidewalk along the road on which people can walk (That is not a barrier.)
  - a railway signal flashing red with its bar down so that no cars can cross (That is a barrier.)
  - a line of orange cones keeping people away from the construction site (That is a barrier.)
  - a ball on the playground (That is not a barrier.)



**Complete Remainder of the Lesson Later in the Day**

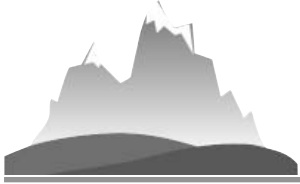

# Daniel Boone and the Opening of the West

1B

**Note:** Extensions may have activity options that exceed the time allocated for this part of the lesson. To remain within the time periods allocated for this portion of the lesson, you will need to make conscious choices about which activities to include based on the needs of your students.

## Extensions

20 minutes

### ↔ Multiple Meaning Word Activity

5 minutes

#### *Sentence in Context: Spoke*

**Note:** You may choose to have students hold up one or two fingers to indicate which image shows the meaning being described, or have a student walk up to the poster and point to the image being described.

1. [Show Poster 1M (Spoke).] In the read-aloud you heard, “Imagine how surprised Native Americans and Europeans must have been to see each other: people who looked, dressed, and *spoke* very differently from themselves.” Here *spoke* means talked to one another. Which picture shows this meaning of *spoke*?
2. A spoke is also one of the bars that connect the center of a wheel to the rim. Which picture shows this meaning of *spoke*? [Point to a spoke of the wheel.]
3. Now with your partner, make a sentence for each meaning of *spoke*. Remember to use complete sentences. I will call on some of you to share your sentences.

### Timeline (Instructional Masters 1B-1 and 1B-2)

10 minutes

- On the class’s timeline, in the blank space right before the Declaration of Independence Image Card, place Image Card 5 (Daniel Boone). Explain to students that Daniel Boone’s

childhood and his explorations took place prior to the signing of the Declaration of Independence. He was an adult around the time of the Boston Tea Party and Paul Revere's ride. Connect these events from *A New Nation: American Independence* with the timeline for *Frontier Explorers*. Tell students that some events from these two domains will overlap.

- Have students begin making their individual timelines. They should put the first five images on their timelines.
- Have partner pairs explain the relationships between the items that they have on their timelines.
- Then have students write a sentence about Daniel Boone's childhood on the back of their timelines, on the row labeled #1.

### **The Appalachian Mountains**

5 minutes

- Have students look at their *Frontier Explorers* Map. Help them identify the area where the first settlers from Europe lived, along the eastern (Atlantic) coast.
- Have students identify the Appalachian Mountains on their maps. Remind students that the Appalachian Mountains were hard to cross, so for several years, the settlers did not move into the land past the mountains.
- Have students use an orange crayon to color the part of the map where the first European settlers lived. Be sure that the colored area does not go past the Appalachian Mountains. [States that should be colored in are New Hampshire, Massachusetts, Rhode Island, Connecticut, New York, Pennsylvania, New Jersey, Delaware, Maryland, Virginia, North Carolina, South Carolina, and Georgia.]
- Have students color the Appalachian Mountains brown. Ask students why these mountains were a barrier to people who wanted to move west.

### **Explorer's Journal #1 (Instructional Master 1B-3)**

15 minutes

- Tell students they will be keeping an *Explorer's Journal* throughout this domain. Explain that a journal is similar to a diary; it is a place where they can record their experiences,

thoughts, and daily events.

- Tell students to pretend that they are settlers thinking about moving to the frontier in the west.
  - First, they should draw a picture about what they think the frontier might look like.
  - Next, they should consider whether the journey into the frontier would be easy or difficult.
  - Then, ask students to write several sentences about whether the journey to the frontier might be easy or difficult and why. Students may use the back of the page to continue writing.
  - Finally, students should share their drawings and writing with their partners or home-language peers.

### ***Checking for Understanding***

Say: “Asking questions is one way to make sure everyone knows what to do. Think of a question you can ask your partner about the directions I have just given you. For example, you could ask, ‘What should we draw in our journal?’ Turn to your partner, and ask your own question now. I will call on several of you to share your questions with the class.”

[Be sure that students understand the four-part instructions to this activity.]

## ***Take-Home Material***

---

### **Family Letter**

---

Send home Instructional Masters 1B-4-6.



# Crossing the Appalachian Mountains

## 2

### ✔ **Lesson Objectives**

---

#### **Core Content Objectives**

---

Students will:

- ✔ Locate the Appalachian Mountains on a map
- ✔ Recall basic facts about Daniel Boone
- ✔ Describe Daniel Boone as a trailblazer
- ✔ Identify what the Wilderness Road refers to

#### **Language Arts Objectives**

---

The following language arts objectives are addressed in this lesson. Objectives aligning with the Common Core State Standards are noted with the corresponding standard in parentheses. Refer to the Alignment Chart for additional standards addressed in all lessons in this domain.

Students will:

- ✔ Distinguish between information provided by an image of Fort Boonesborough and information provided in the read-aloud to determine how forts protect the people living inside (RI.1.6)
- ✔ Identify new meanings for the word *pass* and apply them accurately
- ✔ Prior to listening to “Crossing the Appalachian Mountains,” predict whether Daniel Boone will make it to the land west of the Appalachian Mountains

#### **Core Vocabulary**

---

**passes, *n.*** Ways through mountains, with areas of lower land

*Example:* They used the passes to cross the mountains because it was quicker than climbing all the way up to get to the other side.

*Variation(s):* pass



**pioneers, n.** People who want to explore or live in a place they do not know much about

*Example:* Daniel showed the pioneers who wanted to move west how to cross the Appalachian Mountains.

*Variation(s):* pioneer

**trailblazer, n.** A person that blazes or makes a trail through unknown places for others to follow

*Example:* The trailblazer led the group of settlers through the forest.

*Variation(s):* trailblazers

**wilderness, n.** An area of land that has many wild plants and animals; a place where not many people live and where there are few or no roads

*Example:* When the woodsmen went out into the wilderness, they saw plants they had never seen before.

*Variation(s):* none

Vocabulary Chart for Crossing the Appalachian Mountains			
Core Vocabulary words are in <b>bold</b> . Multiple Meaning Word Activity word is <u>underlined</u> . Vocabulary Instructional Activity words have an asterisk (*). Suggested words to pre-teach are in <i>italics</i> .			
Type of Words	Tier 3 Domain-Specific Words	Tier 2 General Academic Words	Tier 1 Everyday-Speech Words
<b>Understanding</b>	footpath fort Kentucky settler <b>wilderness</b> woodsman	delighted desire fertile identify*	family forest friend hunted mountain road
<b>Multiple Meaning</b>	gaps <b>pioneer*</b> trail <b>trailblazer</b>	<u>pass</u> <b>passes</b> rich	land
<b>Phrases</b>	Appalachian Mountains Cumberland Gap Daniel Boone John Finley Native Americans the pioneering spirit the West Wilderness Road	on the lookout the other side	
<b>Cognates</b>	fuerte <b>pionero(a)*</b>	deleitado deseo fértil identificar* <u>paso</u>	familia foresta montaña

**Note:** Introducing the Read-Aloud and Extensions may have activity options that exceed the time allocated for that part of the lesson. To remain within the time periods allocated for each portion of the lesson, you will need to make conscious choices about which activities to include based on the needs of your students.

Exercise	Materials	Details
<b>Introducing the Read-Aloud (10 minutes)</b>		
<b>Where Are We?</b>	<i>Frontier Explorers</i> Map; U.S. Map	Have students locate where the European settlers lived along the eastern (Atlantic) coast (colored in orange).
	Instructional Master 2A-1 (Cardinal Directions); letters standing for the four cardinal directions written on index cards; tape	Invite partner pairs to think of their own way of remembering NESW. Ask students questions that require them to use cardinal directions in their answers.
<b>What Have We Already Learned?</b>	Instructional Master 2A-2 (Somebody Wanted But So Then chart)	Use this chart to record information about Daniel Boone and other settlers' desires to explore the west. Complete the last two rows (So, Then) during Comprehension Questions #4 and #6.
<b>Making Predictions About the Read-Aloud</b>	<i>Frontier Explorers</i> Map	Have students point to the Appalachian Mountains and the land west of the mountains.
<b>Vocabulary Preview: Wilderness, Trailblazer</b>	Image 2A-6; images of the wilderness	
	Image 2A-7	
<b>Purpose for Listening</b>		
<b>Presenting the Read-Aloud (15 minutes)</b>		
<b>Crossing the Appalachian Mountains</b>	Image Card 6 (Buffalo); <i>Frontier Explorers</i> Map; U.S. map	Help students identify Kentucky, and note that it is to the west of the Appalachian Mountains.
<b>Discussing the Read-Aloud (15 minutes)</b>		
<b>Comprehension Questions</b>	Somebody Wanted But So Then chart	Complete this chart during Questions #4 and #6.
<b>Word Work: Pioneers</b>	Image 2A-5	
 <b>Complete Remainder of the Lesson Later in the Day</b>		

Exercise	Materials	Details
<b>Extensions (20 minutes)</b>		
<b>Multiple Meaning Word Activity: Pass</b>	Poster 2M (Pass)	
<b>Syntactic Awareness Activity: Sentence Types</b>	Instructional Master 2B-1 (Punctuation Marks); Images 2A-1 and 2A-4	
<b>Vocabulary Instructional Activity: Identify</b>	Image 2A-3; Instructional Master 2B-2	
<b>Domain-Related Trade Book</b>	trade book about Daniel Boone; drawing paper and drawing and writing tools	Trade book suggestions: Items 5 and 16.
<b>Song: On Top of Old Smoky [optional]</b>	Image 2A-6; music and lyrics for the first stanza of the song “On Top of Old Smoky”	

### **Advance Preparation**

Make a copy of Instructional Master 2A-1 for each student. This is their compass rose that shows the directions north, east, south, and west. Have students color in their compass rose and write the names of the directions. Students can use their compass rose to practice cardinal directions.

Reproduce Instructional Master 2A-2 (Somebody Wanted But So Then Chart) on large chart paper, or make a copy of Instructional Master 2A-2 on a transparency. Fill in the first three rows as the class reviews the previous read-aloud. The last two rows can be filled in as the class answers comprehension questions #4 and #6.

✈️ **Above and Beyond:** Make copies of Instructional Master 2A-2 for students who are ready to complete the chart on their own.

For Vocabulary Preview, find images of the wilderness to help students gain an understanding of what wilderness is.

Make a copy of Instructional Master 2B-1 for each student. Students will use the end-punctuation pictured in the covered wagon during the syntactic awareness activities in this domain.

For the Vocabulary Instructional Activity, make a copy of Instructional Master 2B-2 for each student. Students will identify animal tracks on this activity page.

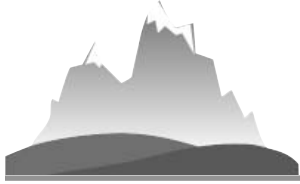

# Crossing the Appalachian Mountains

# 2<sub>A</sub>

**Note:** Introducing the Read-Aloud may have activity options that exceed the time allocated for this part of the lesson. To remain within the time periods allocated for this portion of the lesson, you will need to make conscious choices about which activities to include based on the needs of your students.

## ***Introducing the Read-Aloud***

**10** minutes

### **Where Are We?**

**5** minutes

Have students locate the Appalachian Mountains on a U.S. map. Discuss with students that Native Americans had already been living in North America for thousands of years when settlers arrived in North America from Europe. Review with students that European settlers settled in the land to the east of the Appalachian Mountains, along the east coast of North America.

You may want to discuss with students the concept of cardinal directions. Cardinal directions are the four main points of a compass: north, east, south, and west. *Cardinal* is a word that means basic or most important. North, east, south, and west are the basic, or most important, directions we use to describe our location.

Draw a simple compass rose for students, pointing out each direction: north, east, south, west. Tape the letters representing the four cardinal directions (N, E, S, W) on the appropriate location on the U.S. map. Point to each letter and have students repeat the direction each letter represents. You may wish to teach students a mnemonic device, such as “Never Eat Soggy Waffles.”

### **What Have We Already Learned?**

**10** minutes

Remind students that last time they learned about Daniel Boone. Have students describe Daniel Boone and where he wanted to go. (He was a very good hunter and woodsman. He wanted to

explore land west of the Appalachian Mountains.) Have students share reasons Daniel Boone and other settlers had for crossing the Appalachian Mountains. Review with students why it was difficult to cross the Appalachian Mountains.

**Note:** This is an example of a completed Somebody Wanted But So Then Chart. The last two rows should be filled in during the Comprehension Questions section of the lesson.

<b>Somebody</b>	Daniel Boone and other pioneers
<b>Wanted</b>	wanted to cross the Appalachian Mountains.
<b>But</b>	But it was difficult to cross the Appalachian Mountains.
<b>So</b>	So Daniel Boone helped to widen some Native American trails through the mountains. It was called the Wilderness Road.
<b>Then</b>	Then more European settlers could travel across the Appalachian Mountains and settle in the west.

### Making Predictions About the Read-Aloud

5 minutes

Ask students to use what they learned about Daniel Boone and the Appalachian Mountains to predict whether they think he will make it to the land west of the mountains.

### Vocabulary Preview

5 minutes

#### Wilderness



#### ← Show image 2A-6: Appalachian Mountains

1. In today’s read-aloud you will hear that many settlers wanted to make the hard and dangerous trip through the *wilderness*.
2. Say the word *wilderness* with me three times.
3. The wilderness is a place where trees and other plants grow close together. There may be wild animals in the wilderness. Not many people live in the wilderness and only a few roads, if any, go through the wilderness.
4. Daniel Boone explored the wilderness to the west of where he lived.  
Sean and Shreya wondered what it might be like to camp in the wilderness.

5. [Show images of wilderness.] Look at these pictures, and describe the wilderness to your partner. What kinds of things do you see? (trees, shrubs, different kinds of wild animals) How is the wilderness different from a settlement?



### **Trailblazer**

#### ← Show image 2A-7: Blazing the Wilderness Road

1. In today's read-aloud you will learn that Daniel Boone is known as a famous *trailblazer*.
2. Say the word *trailblazer* with me three times.
3. Which two words do you hear in *trailblazer*? (trail and blazer)  
A trail is a path that goes through a forest or wilderness. *Blaze* can mean a fire or bright light, but here it means to make a spot or mark on trees to show a trail.  
So a trailblazer is someone who creates a trail through the wilderness for others to follow.  
**Note:** Daniel Boone did not actually *create* the trail. He helped to *widen* existing trails created by Native Americans. Widening the trails made it easier for European settlers to travel west.
4. Even though settlers did not know very much about the land west of the Appalachian Mountains, they had trailblazers like Daniel Boone to explore the land and to find or help create trails so others could take the same route.
5. What are these trailblazers doing? (clearing a path through the wilderness using shovels and axes)  
Do you think the work of a trailblazer is exciting or dull? Easy or difficult? Tiring or relaxing?

### **Purpose for Listening**

---

Tell students to listen carefully to find out whether or not their predictions are correct and what happened during Daniel Boone's adventures as a trailblazer.



## Crossing the Appalachian Mountains

### ← Show image 2A-1: Daniel Boone and John Finley

Daniel Boone continued to explore the Appalachian Mountains, always on the lookout for a path that might lead him to the other side. One day he was visited by an old friend, John Finley. As the two men talked, Daniel told John of his desire to find a way to cross the mountains. To his great surprise, Finley replied, “Why, I know a way! I’ve crossed the Appalachians myself.” He told Daniel that he knew of several big gaps in the mountains.<sup>1</sup>

- 1 A gap is a space between two things. Make a face that shows how Daniel Boone might have felt when he heard that John knew a way to cross the Appalachian Mountains.



### ← Show image 2A-2: Cumberland Gap

Formed by rushing water years ago, the natural gaps, or **passes**, through the mountains had been trampled down first by buffalo and later by Native Americans. One pass was not too far from where Daniel Boone and his family lived.<sup>2</sup> “It’s in Virginia, and it’s called the Cumberland Gap,” Finley told him. “It is an old Native American footpath.”<sup>3</sup> Boone was delighted! He asked John Finley to show him how to find it.

- 2 Passes make it easier to cross the mountains than climbing straight up the mountain to get to the other side. The word *pass* also means to give something to someone using your hands.
- 3 You can only walk or ride a horse on a footpath. Wagons cannot fit on a footpath.



### ← Show image 2A-3: Daniel Boone on the trail

Not long after that, the two men set off with four other men on a big adventure to find the Cumberland Gap.<sup>4</sup> They walked and rode on horseback for many miles before reaching the beaten path that led up a steep side of the mountain. They spent long days climbing up and up and up. Daniel’s skills as a woodsman helped him identify animal tracks and follow the Native American footpath.<sup>5</sup> They were overjoyed to reach the top of the mountains where they could see a magnificent river stretching out beneath them. Following the narrow Native American footpath, the men finally made it to the other side of the Appalachian Mountains, to the land that is now known as Kentucky.<sup>6</sup>

- 4 [Point to the state of Virginia on a U.S. map. The Cumberland Gap is near its borders with Kentucky and Tennessee.]
- 5 Remember, a woodsman is someone who can live and survive in the forest.
- 6 Kentucky is located to the west of the Appalachian Mountains, so Daniel Boone made it to the other side!



← **Show image 2A-4: Daniel and friends hunting**

7 [Show Image Card 6 (Buffalo).] Daniel Boone also used traps to catch animals. Boone used these animals for food and for their fur.

Daniel and his friends were pleased with what they found on the other side of the mountains. The land was rich and fertile, and there were great herds of buffalo grazing on grasses. For the next two years Daniel Boone stayed in eastern Kentucky, hunting and trapping wild animals.<sup>7</sup>



← **Show image 2A-5: Daniel Boone and pioneers**

8 A pioneer is someone who wants to explore or live in a place that they don't know very much about.

When he finally returned to North Carolina, he was met by other settlers who expressed an interest in leaving their homes in the east and moving westward. These **pioneers** asked Daniel if he could show them the way across the Appalachian Mountains.<sup>8</sup> “It’s not an easy trip,” Boone told them. “The forests are dense, and there are many dangers along the trail.”



← **Show image 2A-6: Appalachian Mountains**

9 *Wilderness* refers to a place where trees and other plants grow close together, and where people live far apart. Often, there are few roads that go through the wilderness.

But the pioneering spirit of these settlers remained strong. Two years later, they convinced Daniel that they were serious about making the hard and dangerous trip to the **wilderness**.<sup>9</sup> And so, Daniel led his own family, along with several other families, back through the Cumberland Gap into Kentucky. However, the trip proved even harder for families than it had been for the woodsmen. The families were not used to living in the wild outdoors like the woodsmen. Setting up a settlement in Kentucky was more difficult than the pioneers expected, and they were forced to go back home over the Appalachian Mountains.

Later, a businessman offered Daniel Boone a job to help widen some Native American trails that crossed the Appalachian Mountains. He wanted Daniel to make the trails wider and clearly marked so that pioneers would not lose their way as they crossed the mountains. Daniel Boone became known as a **trailblazer**.<sup>10</sup> He helped to open up the way for pioneers to move west.

10 Boone helped to widen the Native American trails, making it easier for families to make the journey to the other side of the Appalachians.





← **Show image 2A-7: Blazing the Wilderness Road**

11 If the forest was in the wilderness were there a lot of trees and plants? Were there many roads?

12 Remember, a footpath is not wide enough for wagons.

13 Why do you think the trail received this name?

14 The Native Americans and the settlers wanted to live on the same land, and sometimes fought about it.



← **Show image 2A-9: Portrait of Daniel Boone**

15 How might the Native Americans who were already living there have felt about the wilderness being destroyed?

Daniel Boone gathered together a group of men to help him widen the trails through the wilderness.<sup>11</sup> Together they worked through rain, snow, and mud. Their axes chopped down trees and bushes to widen the old Native American footpath so that the pioneers' wagons would fit.<sup>12</sup> They built log bridges across streams. Daniel Boone and the men successfully widened a trail from eastern Virginia, through the Cumberland Gap, and into Kentucky. The trail was originally Native American footpaths called The Great Warrior's Path. Later, it became known as the Wilderness Road.<sup>13</sup>

Pioneers from Virginia, North Carolina, and Pennsylvania began to move along the Wilderness Road in great numbers. By the time that Kentucky was declared a state, less than twenty years after the trail was widened, more than one hundred thousand people had used the Wilderness Road. Daniel Boone's hard work in widening the trails helped to open up the area known as "the West" to many European settlers. As more and more settlers streamed into the west, relationships with the Native Americans who were already living there became even more strained.<sup>14</sup>

Life was difficult for the pioneers in the beginning, but people kept streaming across the mountains. In fact, so many people came that Daniel Boone felt his wilderness was being destroyed. It was no longer a wilderness land.<sup>15</sup> He never gave up his love for the wilderness and continued to explore lands to the west of Kentucky until his death at the age of eighty-six.

### Comprehension Questions

10 minutes

If students have difficulty responding to questions, reread pertinent passages of the read-aloud and/or refer to specific images. If students give one-word answers and/or fail to use read-aloud or domain vocabulary in their responses, acknowledge correct responses by expanding students' responses using richer and more complex language. Ask students to answer in complete sentences by asking them to restate the question in their responses.

1. *Evaluative* Were your predictions about whether Daniel Boone would find a way through the Appalachian Mountains correct? Why or why not? (Answers may vary.)
2. *Inferential* How were Daniel Boone and John Finley able to cross the Appalachian Mountains into Kentucky? (Daniel Boone and John Finley crossed the Appalachian Mountains through the Cumberland Gap using a Native American footpath.)
3. *Literal* What did Daniel Boone and his friend do in Kentucky? (Daniel Boone hunted and trapped animals in Kentucky.)
4. *Literal* What did Daniel Boone do to make it easier for the settlers to cross the Appalachian Mountains? (Daniel Boone widened the Native American trails through the mountains.) What did the trail become known as? (the Wilderness Road)
5. *Inferential* Why was it called the Wilderness Road? (It was a road through the wilderness, or forest, where trees and plants were close together and people did not live close together.)
6. *Inferential* Why was the Wilderness Road so important? (The Wilderness Road was important because it allowed many more people to travel to Kentucky and settle there. The road made it easier to transport supplies and easier for families to travel in their wagons.)

[Please continue to model the *Think Pair Share* process for students, as necessary, and scaffold students in their use of the process.]

I am going to ask a question. I will give you a minute to think about the question, and then I will ask you to turn to your neighbor and discuss the question. Finally, I will call on several of you to share what you discussed with your partner.

7. *Evaluative Think Pair Share:* What did it mean when people called Daniel Boone a *trailblazer*? (Answers may vary, but could include that he was the first European settler to travel across the Appalachian Mountains and that he helped pioneers move west.)
8. After hearing today’s read-aloud and questions and answers, do you have any remaining questions? [If time permits, you may wish to allow for individual, group, or class research of the text and/or other resources to answer these questions.]



### Word Work: Pioneers

5 minutes

#### ← Show image 2A-5: Daniel Boone and pioneers

1. In the read-aloud you heard, “These *pioneers* asked Daniel if he could show them the way across the Appalachian Mountains.”
2. Say the word *pioneers* with me.
3. Pioneers are people who want to explore and live in unknown places.
4. The pioneers packed their belongings and moved west.
5. What kinds of traits or characteristics do you think describe pioneers? Try to use the word *pioneers* when you tell about them. [Ask two or three students. If necessary, guide and/ or rephrase students’ responses: “Pioneers are people who are . . . ”]
6. What’s the word we’ve been talking about?

Use a *Making Choices* activity for follow-up. Directions: I am going to read some activities that people might do. If it sounds like something that Daniel Boone and the other pioneers might have done, you will say, "Pioneers would have done that." If it does not sound like something Daniel Boone and the other pioneers would have done, you will say, "Pioneers would not have done that."

1. traveling long distances (Pioneers would have done that.)
2. building fires to keep warm (Pioneers would have done that.)
3. staying and settling in a big city (Pioneers would not have done that.)
4. shooting wild birds for dinner (Pioneers would have done that.)
5. building new log cabins in the wilderness (Pioneers would have done that.)



### **Complete Remainder of the Lesson Later in the Day**

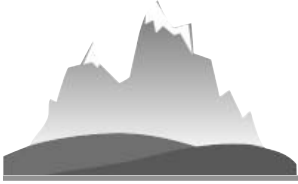

# Crossing the Appalachian Mountains

# 2<sub>B</sub>

**Note:** Extensions may have activity options that exceed the time allocated for this part of the lesson. To remain within the time periods allocated for this portion of the lesson, you will need to make conscious choices about which activities to include based on the needs of your students.

## Extensions

**20** minutes

### ↔ Multiple Meaning Word Activity

5 minutes

#### *Definition Detective: Pass*

**Note:** You may choose to have students hold up one, two, three, or four fingers to indicate which image shows the meaning being described, or have a student walk up to the poster and point to the image being described.

1. In the read-aloud you heard the word *pass* when John Finley, Daniel Boone's friend, told him about a *pass* through the mountains.
2. With your partner, think of as many meanings or ways as you can to use the word *pass*.
3. [Show Poster 2M (Pass).] In the read-aloud, a *pass* is a place that goes through the mountains. Which picture shows this type of *pass*?
4. A *pass* can also be a ticket, such as a ticket to ride on a bus. Which picture shows this type of *pass*?
5. *To pass* means to give something to someone. Which picture shows this meaning of *pass*?
6. *To pass* also means to move ahead of someone or something else. For example, one train passes another train. Which picture shows this meaning of *pass*?

7. Did you or your partner think of any of these definitions?
8. With your partner, make up a sentence for each meaning of *pass*. I will call on some of you to share your sentence. [Call on a few partner pairs to share one or all of their sentences. Have them point to the part of the poster that relates to their use of *pass*.]

## ↔ Syntactic Awareness Activity (Instructional Master 2B-1)

5 minutes

### *Sentence Types*

**Note:** The purpose of these syntactic activities is to help students understand the direct connection between grammatical structures and the meaning of text. These syntactic activities should be used in conjunction with the complex text presented in the read-alouds. There may be variations in the sentences created by your class. Allow for these variations, and restate students' sentences so that they are grammatical. If necessary, have students repeat the sentence after you.

Please change the inflection of your voice to match the punctuation of the sentences you read aloud. Have students hold up the end punctuation for the sentences.



### ← Show image 2A-1: Daniel Boone and John Finley

1. Every day we use different types of sentences as we talk to others. We use sentences that give information, ask questions, or shout or exclaim something exciting.
2. One type of sentence we use is to tell others information. In the read-aloud, you heard John Finley tell Daniel Boone, “[There is a pass] in Virginia called the Cumberland Gap.” [Hold up the period.] This sentence ends in a period because it gives information. You say it in a regular tone of voice. Now you try! I am going to say two sentences. Hold up the period when you hear me say a sentence that gives information.
  - There is a pass through the mountains.
  - There is a pass through the mountains?

3. Another type of sentence we use is to ask questions. For example, Daniel Boone asked his friend, “Can you show me the pass?”

[Hold up the question mark.] This sentence ends in a question mark because it asks a question. You change the tone of your voice when you ask a question, sometimes by making the sound of your voice become higher at the end of the sentence.

Now you try! I am going to say two sentences. Hold up the question mark when you hear me say a sentence that asks a question.

- The pass is over here.
- The pass is over here?



← **Show image 2A-4: Daniel and friends hunting**

4. Another type of sentence we use is to let others know we are very excited about something. While Daniel and his friends were hunting, they might have said, “Look at those buffalo!”

[Hold up the exclamation point.] This sentence ends in an exclamation point because it expresses excitement.

Now you try! I am going to say two sentences. Hold up the exclamation point when you hear me say a sentence that exclaims something.

- Watch out for that bear.
  - Watch out for that bear!
5. What are the three types of sentences we use? What kind of punctuation do we use for each type of sentence? (sentences that give information/period; sentences that ask questions/question mark; sentences that exclaim something/exclamation point)

## ↔ Vocabulary Instructional Activity (Instructional Master 2B-2)

15 minutes



### *Word Work: Identify*

#### ← Show image 2A-3: Daniel Boone on the trail

1. In the read-aloud you heard, “Daniel’s skills as a woodsman helped him *identify* animal tracks and follow the Native American footpath.”
2. Say the word *identify* with me three times.
3. *Identify* means to figure out or show who someone is or what something is.
4. Daniel could identify the tracks of all sort of wild animals. Devon’s mother used her driver’s license to identify herself.
5. Why do you think Daniel Boone could identify animal tracks? [Ask two or three students. If necessary, guide and/or rephrase the students’ responses: “Daniel Boone could identify animal tracks because . . .”]
6. What’s the word we’ve been talking about?

Use a *Word to World* activity for follow-up. Directions: Let’s see which animal tracks you can identify. Try to match the picture of the animal on the left to its tracks on the right.

### *Extending the Activity*

An engaging extension to the Vocabulary Instructional Activity for *identify* would be to continue to study animal tracks. Refer to the following websites for ideas:

<http://education.usgs.gov/kids/tracks.html>

[http://files.dnr.state.mn.us/education\\_safety/education/project\\_wild/animal-tracks.pdf](http://files.dnr.state.mn.us/education_safety/education/project_wild/animal-tracks.pdf)



## Domain-Related Trade Book

20+ minutes

- Refer to the list of recommended trade books in the Introduction at the front of this *Supplemental Guide*, and choose one trade book about Daniel Boone to read aloud to the class. [Suggested trade books are items numbered 5 and 16 on the list.]
- Explain to students that the person who wrote the book is called the author. Tell students the name of the author. Explain to students that the person who makes the pictures for the book is called an illustrator. Tell students the name of the illustrator. Show students where they can find this information on the cover of the book or on the title page.
- As you read, use the same strategies that you have been using when reading the read-aloud selections—pause and ask text-based questions to ensure comprehension; rapidly clarify critical vocabulary within the context of the read-aloud; etc.
- After you finish reading the trade book aloud, lead students in a discussion as to how the story or information in this book relates to the read-alouds in this domain. Discuss whether the trade book was fiction or nonfiction, fantasy or reality, historical or contemporary.
- Provide students with drawing paper, drawing tools and writing tools. Have students draw one detail they remember from the trade book. Students may also draw one new thing that they learned from the trade book that they did not know before. Students should label their pictures and write a sentence to go along with their drawings. Have students share their drawings and writing with their partners or with home-language peers.



### Song: On Top of Old Smoky [optional]

#### ← Show image 2A-6: Appalachian Mountains

- You may wish to teach the first stanza of the song “On Top of Old Smoky.” “Old Smoky” refers to a part of the Appalachian Mountain range called the Old Smoky Mountains.



# Jefferson and Monroe

# 3

## ✓ **Lesson Objectives**

---

### **Core Content Objectives**

---

Students will:

- ✓ Locate the Mississippi River on a map
- ✓ Locate the Rocky Mountains on a map
- ✓ Explain why Thomas Jefferson wanted to purchase New Orleans

### **Language Arts Objectives**

---

The following language arts objectives are addressed in this lesson. Objectives aligning with the Common Core State Standards are noted with the corresponding standard in parentheses. Refer to the Alignment Chart for additional standards addressed in all lessons in this domain.

Students will:

- ✓ With assistance, create and interpret a timeline of the settlement of North America (W.1.8)
- ✓ Ask and answer *who* questions orally, requiring literal recall and understanding of the details and facts from “Jefferson and Monroe” (SL.1.2)
- ✓ Describe the images from the read-aloud to retell the read-aloud with relevant details, expressing ideas and feelings clearly (SL.1.4)
- ✓ Identify simple declarative, interrogative, and exclamatory sentences orally in response to prompts

## Core Vocabulary

**emperor, n.** A man who rules an empire or country.

[An empress is a female ruler of an empire.]

*Example:* The people bowed when the emperor entered the room.

*Variation(s):* emperors

**intelligent, adj.** Very smart; quick to learn and understand

*Example:* Thomas Jefferson had an intelligent friend who was able to solve many problems.

*Variation(s):* none

**loyal, adj.** Faithful and strong in his or her support of a person, thing, or idea

*Example:* A loyal friend sticks by your side, no matter what.

*Variation(s):* none

**mouth, n.** The part of a stream or river that empties into a larger body of water.

*Example:* They entered the ocean from the mouth of the river.

*Variation(s):* mouths

Vocabulary Chart for Jefferson and Monroe			
Core Vocabulary words are in <b>bold</b> . Multiple Meaning Word Activity word is <u>underlined</u> . Vocabulary Instructional Activity words have an asterisk (*). Suggested words to pre-teach are in <i>italics</i> .			
Type of Words	Tier 3 Domain-Specific Words	Tier 2 General Academic Words	Tier 1 Everyday-Speech Words
Understanding	<b>emperor</b> France Napoleon president	agree important <b>intelligent</b> job <b>loyal*</b> owned supply	angry/happy boat buy/sell city friend money ocean river
Multiple Meaning		state	<b>mouth</b> ship
Phrases	James Monroe Mississippi River <i>New Orleans</i> Thomas Jefferson	it will be my honor to open up	
Cognates	<b>emperador</b> Francia Napoleón presidente	importante <b>inteligente</b> <b>leal*</b>	bote ciudad océano

**Note:** Introducing the Read-Aloud and Extensions may have activity options that exceed the time allocated for that part of the lesson. To remain within the time periods allocated for each portion of the lesson, you will need to make conscious choices about which activities to include based on the needs of your students.

Exercise	Materials	Details
<b>Introducing the Read-Aloud (10 minutes)</b>		
<b>What Have We Already Learned?</b>	Timeline; Image Card 5 (Daniel Boone); timeline; <i>Frontier Explorers</i> Map	Use these supports to review information about Daniel Boone and to show how settlers moved west and forced many Native Americans to move even further west.
	Image Card 8 (Thomas Jefferson); Instructional Master 3A-1 (Idea Web), chart paper, chalkboard, whiteboard	Make an Idea Web about what students know about Thomas Jefferson.
<b>Where Are We?</b>	<i>Frontier Explorers</i> Map; world map	Have students locate the Appalachian Mountains and the original thirteen colonies. Point to England, and remind students that the Pilgrims and early settlers came from England. Point to France, and explain that there were also explorers and settlers from France.
<b>Vocabulary Preview: Emperor, New Orleans</b>	Image 3A-7; images of emperors	
	Image 3A-1; <i>Frontier Explorers</i> Map, yellow crayon or marker; images of present-day New Orleans	
<b>Purpose for Listening</b>	Image 3A-2	Before beginning the read-aloud, establish that Thomas Jefferson and James Monroe were good friends.
<b>Presenting the Read-Aloud (15 minutes)</b>		
<b>Jefferson and Monroe</b>		
<b>Discussing the Read-Aloud (15 minutes)</b>		
<b>Comprehension Questions</b>		
<b>Word Work: Loyal</b>		
 <b>Complete Remainder of the Lesson Later in the Day</b>		

Exercise	Materials	Details
<b>Extensions (20 minutes)</b>		
<b>Syntactic Awareness Activity: Sentence Types</b>	Punctuation Marks; Images 3A-7 and 3A-8	
<b>Timeline</b>	Image Cards 7 (Eastern United States) and 8 (Thomas Jefferson); timeline	Add the Eastern U.S. and Thomas Jefferson to the timeline. Stress that at the time of this read-aloud, the colonies had declared independence from Britain and Thomas Jefferson was the third president of the United States.
<b>The Mississippi River</b>	<i>Frontier Explorers</i> Map; blue, orange, and brown crayons or markers; U.S. map	
<b>Explorer's Journal #2</b>	Instructional Master 3B-1	

### Advance Preparation

Make a large Idea Web for Thomas Jefferson. Record what students already know about Thomas Jefferson from *A New Nation: American Independence*.

- ✈ Above and Beyond: Make a copy of Instructional Master 3A-1 for students who are ready to complete this web on their own.

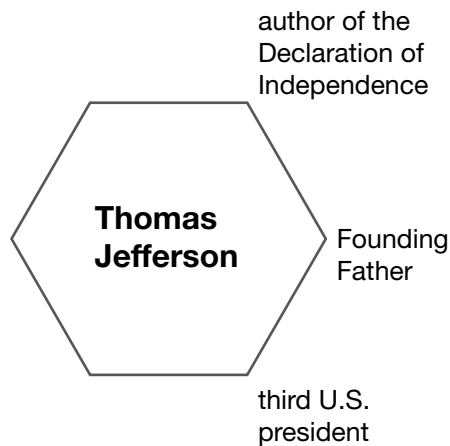

For Vocabulary Preview, find images of emperors and present-day New Orleans.

Make a copy of Instructional Master 2B-1 for each student. This will be the second page of the students' Explorer's Journal. They will write about why Thomas Jefferson would want to buy New Orleans from France.

### ***Notes to Teacher***

Use image 3A-4 to remind students that at the time of this read-aloud, the United States was much smaller than it is today, but larger than the original thirteen colonies. Point to the orange area on the map, and explain that this area belonged to the United States at that time. Point to the green area on the map, and explain that France claimed this land. Emphasize that this green area did not belong to the United States, but more and more Americans were settling nearby and using the Mississippi River.



# Jefferson and Monroe

3A

**Note:** Introducing the Read-Aloud may have activity options that exceed the time allocated for this part of the lesson. To remain within the time periods allocated for this portion of the lesson, you will need to make conscious choices about which activities to include based on the needs of your students.

## ***Introducing the Read-Aloud***

**10** minutes

### **What Have We Already Learned?**

**10** minutes

Using the timeline, remind students that the read-alouds they heard about Daniel Boone took place prior to the United States becoming a country, when the thirteen colonies had just started talking about declaring independence from Great Britain. Use Image Cards 5 (Daniel Boone) to review what students learned about Daniel Boone and other settlers' desire to move west of the Appalachian Mountains.

Discuss with students that Native Americans had already been living in North America for thousands of years when settlers arrived in North America from Europe. As these settlements became colonies, many Native Americans were forced to move away from their family lands in the east. Some moved west over the Appalachian Mountains.

The Wilderness Road that Daniel Boone helped create made it easier for pioneer families to move west over the Appalachian Mountains, which in time expanded the area of the United States. This displaced many Native Americans already living in the area, or forced them to leave their homes and move even further west.

Show students Image Card 8 (Thomas Jefferson). Ask students what they already know about Thomas Jefferson from the *A New Nation* domain. Explain that by this time, the colonies had already declared independence from Great Britain, and Thomas Jefferson was the third president of the country called the United States.



## Where Are We?

5 minutes

### ← Show image 3A-1: Map of the early United States

Explain to students that in today's read-aloud, the United States of America (shown in orange) had grown to include more land than there had been in the original thirteen colonies. Pioneer families had crossed the Appalachian Mountains and settled in lands on the other side of these mountains, pushing the borders of the United States farther and farther west, and forcing the Native Americans who lived in those areas to also move farther and farther west.

Point to the green area on the map, and then identify the city of New Orleans and the Mississippi River. Explain to students that, at the time of today's read-aloud, this area of land, or territory, was not part of the United States. This part of North America had been explored and settled by people from another European country far across the Atlantic—the country of France. Ask students if they remember where the Pilgrims and other early settlers about whom they have already learned came from. (England)

## Vocabulary Preview

5 minutes

### *Emperor*



### ← Show image 3A-7: Napoleon Bonaparte

1. In today's read-aloud you will hear about an *emperor* of France named Napoleon.
2. Say the word *emperor* with me three times.
3. An emperor is a man who rules an empire or country.  
**Note:** An empress is a woman who rules an empire or is the wife of the emperor.
4. All the people bowed when the emperor walked into the room.
5. Does Napoleon look like an emperor in this image?  
[Show additional images of emperors.] How can you tell that this man is an emperor? (wears a crown, dressed in royal clothing)  
[A king is the ruler of a kingdom, and an emperor is ruler of an empire. Usually, a kingdom refers to one country and is smaller than an empire, which can include several countries.]





### ***New Orleans***

#### ← **Show image 3A-1: Map of the early United States**

1. In today's read-aloud you will hear about a city called *New Orleans*.
2. Say the name of this city, *New Orleans*, with me three times.
3. [Point to Louisiana on a map.] New Orleans is a big port and large city in Louisiana. New Orleans is located near the end of the Mississippi river.
4. At the time of today's read-aloud, France owned New Orleans. [Have students circle New Orleans yellow on their maps.]
5. [Show images of New Orleans. Stress that this city was an important port city.] Do you see boats and ships going in and out of the port of New Orleans? Why do you think New Orleans was an important city?



### **Purpose for Listening**

---

#### ← **Show image 3A-2: Monroe and Jefferson**

Explain to students that in today's read-aloud, they will hear about the third president of the United States. In this painting, Jefferson (on the right) is talking to his good friend, James Monroe (on the left). Jefferson is going to ask his good friend to do something for him. Tell students to listen carefully to find out what Jefferson would like Monroe to do.



## Jefferson and Monroe

### ← Show image 3A-2: Monroe and Jefferson

Entering his office in Washington, D.C., Thomas Jefferson, president of the United States, was pleased<sup>1</sup> to find his friend, James Monroe, waiting for him. Monroe politely rose to his feet, but President Jefferson said, “Sit down, James. This is not a formal meeting, as you can see.” In fact, Thomas Jefferson was dressed in his robe and slippers!<sup>2</sup>

As the two men sat down, James Monroe thought to himself, “Thomas Jefferson doesn’t try to make himself look fancy or important. But he is the smartest, most interesting person I have ever known. How lucky I am to be his friend!”

At the same time, President Jefferson was thinking, “James Monroe is honest and **intelligent**,<sup>3</sup> and he is willing to work hard to do a good job.”<sup>4</sup>

1 or glad

2 [Point to Monroe and then Jefferson in the picture.]

3 or smart

4 Monroe and Jefferson are describing each other’s characteristics. Do you think Monroe and Jefferson sound like they would be good leaders for our country?



### ← Show image 3A-3: Making plans

Speaking out loud now, the president said, “James, I have an important job I want you to do, one that I think you are especially well-suited to carry out: I want you to buy a city for us.”<sup>5</sup>

“I beg your pardon!” James Monroe exclaimed in surprise. “Buy a city?”

“Yes, I want to send you to France to see the **Emperor** Napoleon, who rules France and half of Europe as well.<sup>6</sup> When you reach France, I want you to buy the city of New Orleans from Napoleon.”

5 Have you ever heard of someone buying a whole city?

6 An emperor is a male ruler, like a king. [Remind students of the emperors they have already learned about in *Early American Civilizations*.]



### ← Show image 3A-4: Map of the early United States

James Monroe knew that the city of New Orleans sat near the **mouth** of the Mississippi River.<sup>7</sup> French settlers started settling in New Orleans many years ago because they knew that ships and boats could travel up and down the Mississippi River, allowing

7 The mouth of the Mississippi River is where the river empties into the sea. The word *mouth* also means the body part you use to talk and smile!

8 [Trace the ships' journeys up and down the Mississippi River on the map.] It was easier than walking or using a horse and wagon.

9 [Point to the Rocky Mountains on the map. Explain to students that France owned the land from the Mississippi River to the Rocky Mountains.]

10 [Point to the orange area on the map, which represents the size of the United States at that time.]



← **Show image 3A-5: A frontier village along the Mississippi**

11 What group of people had been living on both sides of the Mississippi River for thousands of years? (Native Americans)

12 The Americans were able to sail past New Orleans on their way from the ocean up and down the river. What do you think President Jefferson was worried might happen if Napoleon got angry?

people to buy and sell with one another all along the length of the great Mississippi River.<sup>8</sup> James Monroe knew that France still owned New Orleans, plus a great deal of land west of the Mississippi River stretching all the way to the Rocky Mountains.<sup>9</sup>

Jefferson stopped and stared into the flames of the fire by which they sat, for it was a chilly morning. Then he continued, "As you know, James, our nation, the United States, is on the eastern side of the Mississippi, while the area that France has claimed is on the western side."<sup>10</sup>

"More and more Americans are moving near the Mississippi and building towns and cities along the river."<sup>11</sup> We must make sure Americans can do business up and down the river if we are going to build up that part of the United States. Right now, France and the United States are friends, and Napoleon lets American ships pass by New Orleans on their way from the ocean up and down the river; but if Napoleon ever grew angry with us . . ."<sup>12</sup>

"I understand," said James Monroe. "Napoleon could stop our ships and boats from bringing us the things we need. He could stop our farmers in that part of the country from sending food they grow to the rest of us back east, or stop people in the east from shipping farm tools to the farmers. I understand why New Orleans is important. But why would Napoleon want to sell the city?"



← **Show image 3A-6: Napoleon Bonaparte in battle**<sup>13</sup>

13 [Have students describe the man in the image.]

Jefferson answered, "Napoleon needs as much money as he can get his hands on so that he can pay for supplies, uniforms, food, and ships for his soldiers and sailors because France is fighting in a war in Europe. We will offer to pay him the money he wants, which will make *him* happy, and we will get control of the river, which will make *us* happy."

"Napoleon certainly seems to have a reason to sell New Orleans to us," said Monroe.



14 [Tell students that this is a picture of the emperor Napoleon.]

15 Loyal friends stick by your side no matter what.

16 This means Americans would be able to settle even further west.



← **Show image 3A-7: Napoleon Bonaparte**<sup>14</sup>

Jefferson replied, “He may have a reason, but we must get Napoleon to agree to the sale. He can be very difficult to work with, James. He thinks he is the most important person alive. If he believes you think so, too, he can be a **loyal**, powerful friend.”<sup>15</sup> On the other hand, if he thinks you do not see him as important, or do not agree with his ideas, he will have his servants throw you out of his palace and slam the door. James, you are so likeable, he’ll want to work with you. If you succeed, you will help us to open up the whole western part of our country that is near the Mississippi River. Will you try?”<sup>16</sup>

← **Show image 3A-8: Jefferson and Monroe shaking hands**

James Monroe stood up. “It will be my honor to do so,” he said. Thomas Jefferson arose and the two friends shook hands. As he turned to go, James Monroe thought, “When I came here this morning, I had no idea I would be going to France for the president of the United States! And just think—I am going there to buy a city!”

## Discussing the Read-Aloud

**15** minutes

### Comprehension Questions

**10** minutes

If students have difficulty responding to questions, reread pertinent passages of the read-aloud and/or refer to specific images. If students give one-word answers and/or fail to use read-aloud or domain vocabulary in their responses, acknowledge correct responses by expanding students’ responses using richer and more complex language. Ask students to answer in complete sentences by asking them to restate the question in their responses.

1. *Literal* Who was the president of the United States at the time of this read-aloud? (The president of the United States was Thomas Jefferson.)
2. *Literal* Who was James Monroe? (James Monroe was Thomas Jefferson’s friend.)



3. *Literal* What did Thomas Jefferson ask James Monroe to do? (Thomas Jefferson wanted James Monroe to go to France and buy New Orleans from Napoleon.)

← **Show image 3A-4: Map of the early United States**

4. *Literal* Point to the area on the map that shows the area of land included in the United States of America at the time of this read-aloud. (Students should point to the eastern portion that is highlighted in orange.)
5. *Inferential* [Point to the Mississippi River and New Orleans, and remind students that at the time of this read-aloud, this part of North America had been settled by people from France, but that more and more Americans were settling nearby and using the Mississippi River.] At the time of this read-aloud, how did people use the Mississippi River? (Ships and boats traveled up and down it, carrying people and supplies.) Why did people use the river? (It was easier than walking or using horses.)
6. *Literal* Who was Napoleon? (Napoleon was the emperor or leader of France.)
7. *Inferential* Thomas Jefferson was worried about what might happen if Napoleon suddenly wouldn't let American ships pass through New Orleans. If this happened, would the Americans be able to use the Mississippi River to go to and from the ocean? (no) Why not? (In order to get to the Mississippi River from the ocean, people would have to go through New Orleans.)
8. *Inferential* Why did Thomas Jefferson want to buy New Orleans? (He wanted to make sure that Americans would always be able to go through New Orleans on their way to or from the Mississippi River and the ocean.)

[Please continue to model the *Question? Pair Share* process for students, as necessary, and scaffold students in their use of the process.]

9. *Evaluative Who? Pair Share:* Asking questions after a read-aloud is one way to see how much everyone has learned. Think of a question you can ask your neighbor about the read-aloud that starts with the word *who*. For example, you could ask, “Who did you hear about in today’s read-aloud?” Turn to your neighbor and ask your *who* question. Listen to your neighbor’s response. Then your neighbor will ask a new *who* question, and you will get a chance to respond. I will call on several of you to share your questions with the class.
10. After hearing today’s read-aloud and questions and answers, do you have any remaining questions? [If time permits, you may wish to allow for individual, group, or class research of the text and/or other resources to answer these questions.]

### **Word Work: Loyal**

5 minutes

1. In the read-aloud you heard Thomas Jefferson tell James Monroe, “[Napoleon] can be a *loyal*, powerful friend.”
2. Say the word *loyal* with me.
3. *Loyal* describes someone or something who is faithful and strong in his or her support for a person, thing, or idea.
4. A loyal friend sticks by your side no matter what.
5. What is something a loyal person might do?  
[Prompt students by asking whether certain actions are loyal. For example, you could ask, “Is keeping a friend’s secret something a loyal friend would do?” Ask two or three students. If necessary, guide and/or rephrase students’ responses: “A loyal person . . .”]
6. What’s the word we’ve been talking about?

Use a *Synonyms and Antonyms* activity for follow-up. Directions: I am going to say some words that are either a synonym, or similar to, or an antonym, or an opposite of, *loyal*. If it is a synonym, say, “That is loyal.” If it is an antonym, say, “That is not loyal.”

- faithful (That is loyal.)
- sneaky (That is not loyal.)
- trustworthy (That is loyal.)
- dedicated (That is loyal.)
- dishonest (That is not loyal.)
- false (That is not loyal.)
- reliable (That is loyal.)



**Complete Remainder of the Lesson Later in the Day**

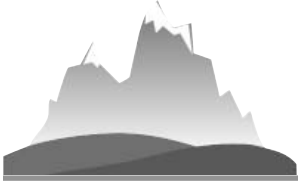

# Jefferson and Monroe

3<sub>B</sub>

**Note:** Extensions may have activity options that exceed the time allocated for this part of the lesson. To remain within the time periods allocated for this portion of the lesson, you will need to make conscious choices about which activities to include based on the needs of your students.

## Extensions

20 minutes

### ↔ Syntactic Awareness Activity: Sentence Types

5 minutes

#### *Sentence Types*

**Note:** The purpose of these syntactic activities is to help students understand the direct connection between grammatical structures and the meaning of text. These syntactic activities should be used in conjunction with the complex text presented in the read-alouds. There may be variations in the sentences created by your class. Allow for these variations, and restate students' sentences so that they are grammatical. If necessary, have students repeat the sentence after you.

Please change the inflection of your voice to match the punctuation of the sentences you read aloud. Have students hold up the end punctuation for the sentences.



#### ← Show image 3A-7: Napoleon Bonaparte

1. Every day we use different types of sentences as we talk to others. We use sentences that give information, ask questions, or shout or exclaim something exciting.
2. One type of sentence we use is to tell others information. The read-aloud told us, "Napoleon was the emperor of France." [Hold up the period.] This sentence ends in a period because it gives information. You say it in a regular tone of voice. Now you try! I am going to say two sentences. Hold up



the period when you hear me say a sentence that gives information.

- Napoleon can be a loyal friend?
- Napoleon can be a loyal friend.



← **Show image 3A-8: Jefferson and Monroe shaking hands**

3. Another type of sentence we use is to ask questions. In the read-aloud you heard Jefferson ask Monroe, “Will you go to France for me?”  
[Hold up the question mark.] This sentence ends in a question mark because it asks a question. You change the tone of your voice when you ask a question, sometimes by making the sound of your voice become higher at the end of the sentence.  
Now you try! I am going to say two sentences. Hold up the question mark when you hear me say a sentence that asks a question.
  - Napoleon is selling the city?
  - Napoleon is selling the city.
4. Another type of sentence we use is to let others know we are very excited about something. In the read-aloud, James Monroe thought, “I am going to France to buy a city!”  
[Hold up the exclamation point.] This sentence ends in an exclamation point because it expresses excitement.  
Now you try! I am going to say two sentences. Hold up the exclamation point when you hear me say a sentence that exclaims something.
  - Jefferson wants Monroe to buy a city?
  - Jefferson wants Monroe to buy a city!
5. What are the three types of sentences we use? What kind of punctuation do we use for each type of sentence? (sentences that give information/period; sentences that ask questions/question mark; sentences that exclaim something/exclamation point)

## Timeline

10 minutes

- Review information that is already on the timeline. Emphasize that Daniel Boone’s childhood (Image Card 5) and his explorations took place prior to the signing of the Declaration of Independence (Image Card 4).
- Add Image Card 7 (Eastern United States) after the Declaration of Independence. Tell students that at the time of today’s read-aloud, the United States had already become a nation and pioneers had crossed the Appalachian Mountains and settled in lands on the other side of the mountains.
- Add Image Card 8 (Thomas Jefferson) after Image Card 7. Remind students that at the time of today’s read-aloud, Jefferson was the president of the United States.
- Have students add these images to their individual timelines.
- Have partner pairs explain the relationships between the items that they have on their timelines.
- Then have students write a sentence about Thomas Jefferson’s idea on the back of their timelines, on the row labeled #2.

## The Mississippi River

5 minutes

- Review the areas students have colored in—the original thirteen colonies, the Appalachian Mountains, and New Orleans.
- Help students locate the Mississippi River on their maps. Ask: “Why is the Mississippi River important?” (Ships and boats traveled up and down this river, carrying people and supplies.)
- Have students trace the Mississippi River in blue.
- Remind students that by the time of today’s read-aloud, pioneers had already crossed the Appalachian Mountains and settled on the other side. Have students color the states on the other side of the Appalachian Mountains up to the Mississippi River orange. Ask students: “Has the United States grown larger?”
- Last, help students locate the Rocky Mountains. Remind students that at the time of today’s read-aloud, France

owned the land between the Mississippi River and the Rocky Mountains. Have students color the Rocky Mountains brown.

## Explorer's Journal #2 (Instructional Master 3B-1)

15 minutes

- Go back through the Flip Book images from the read-aloud, and have students briefly retell the story. Make sure students understand the importance of the Mississippi River and why Thomas Jefferson wanted to buy New Orleans.
- Tell students that they will continue writing in their *Explorer's Journal*. Explain that a journal is similar to a diary; it is a place where they can record their experiences, thoughts, and daily events.
- Tell students to pretend that they are Thomas Jefferson and to write a few sentences to explain why buying New Orleans from France is important.
  - First, they should look at the map on their journal page and locate the Mississippi River and New Orleans.
  - Next, they should consider why these two places are important.
  - Then, ask students to write several sentences about why buying New Orleans is important to Thomas Jefferson.
  - Finally, students should share their writing with their partner or home-language peers.

### ***Checking for Understanding***

Say: "Asking questions is one way to make sure everyone knows what to do. Think of a question you can ask your partner about the directions I have just given you. For example, you could ask, 'What do we need to write about?' Turn to your partner, and ask your own question now. I will call on several of you to share your questions with the class."

[Be sure that students understand the four-part instructions to this activity.]



# The Louisiana Purchase

# 4

## ✔ Lesson Objectives

---

### Core Content Objectives

---

Students will:

- ✓ Locate the Mississippi River on a map
- ✓ Locate the Rocky Mountains on a map
- ✓ Identify and locate the Louisiana Territory on a map
- ✓ Explain the significance of the Louisiana Territory and Purchase

### Language Arts Objectives

---

The following language arts objectives are addressed in this lesson. Objectives aligning with the Common Core State Standards are noted with the corresponding standard in parentheses. Refer to the Alignment Chart for additional standards addressed in all lessons in this domain.

Students will:

- ✓ Compare and contrast emperors and presidents (RI.1.9)
- ✓ Ask and answer *what* questions orally, requiring literal recall and understanding of the details and facts from “The Louisiana Purchase” (SL.1.2)
- ✓ Identify new meanings for the word *letter* and apply them accurately

### Core Vocabulary

---

**brilliant, *adj.*** Very bright or smart; someone with new ideas

*Example:* George Washington was a brilliant army leader who came up with a plan to attack the British army by surprise.

*Variation(s):* none

**clever, *adj.*** Able to quickly and easily solve problems

*Example:* Thomas Jefferson was clever to ask Napoleon if he could buy New Orleans from France.

*Variation(s):* none

**mansion, n.** A very large house

*Example:* The beast lived in the mansion all by himself.

*Variation(s):* mansions

**purchase, v.** To buy

*Example:* Maria saved enough money to purchase the book she wanted at the book fair.

*Variation(s):* purchases, purchased, purchasing

**territory, n.** A large area of land ruled by the government of another country

*Example:* The Louisiana Territory was controlled by France before it became part of the United States.

*Variation(s):* territories

<b>Vocabulary Chart for The Louisiana Purchase</b>			
Core Vocabulary words are in <b>bold</b> .			
Multiple Meaning Word Activity word is <u>underlined</u> .			
Vocabulary Instructional Activity words have an asterisk (*).			
Suggested words to pre-teach are in <i>italics</i> .			
<b>Type of Words</b>	<b>Tier 3</b> Domain-Specific Words	<b>Tier 2</b> General Academic Words	<b>Tier 1</b> Everyday-Speech Words
<b>Understanding</b>	emperor France <b>mansion</b> Napoleon palace <b>territory</b>	<b>clever*</b> controlled discuss owned <b><i>purchase</i></b> size	buy/sell city home money weeks
<b>Multiple Meaning</b>	bargain	<b>brilliant</b> double* meeting offer	answer land <u>letter</u> pen
<b>Phrases</b>	James Monroe Louisiana Purchase Louisiana Territory Mississippi River New Orleans Thomas Jefferson	a fair price double the size gain control of seal this bargain	
<b>Cognates</b>	emperador Francia Napoleón palacio <b>territorio</b>	controlado discutir doble* oferta	ciudad

**Note:** Introducing the Read-Aloud and Extensions may have activity options that exceed the time allocated for that part of the lesson. To remain within the time periods allocated for each portion of the lesson, you will need to make conscious choices about which activities to include based on the needs of your students.

Exercise	Materials	Details
<b>Introducing the Read-Aloud (10 minutes)</b>		
<b>Where Are We?</b>	Cardinal Directions activity page; U.S. map with cardinal directions  <i>Frontier Explorers</i> Map; U.S. map	Review that the land east of the Mississippi River belonged to the United States and the land to the west of the Mississippi, up to the Rocky Mountains, belonged to France. Remind students that the Native Americans lived on that land for a long time before the English or French settlers came to North America. Show how the Native Americans were forced to move further and further west.
<b>What Have We Already Learned?</b>	Image 4A-2; Instructional Master 3A-1 (Idea Web), chart paper, chalkboard, whiteboard	Use Flip Book image to locate the Mississippi River and New Orleans. Create an Idea Web for New Orleans to record student responses to the question: “Why did President Jefferson want to buy New Orleans from France?”
<b>Setting</b>	world map	
<b>Vocabulary Preview: Purchase, Territory</b>	Image 4A-2	
<b>Purpose for Listening</b>		
<b>Presenting the Read-Aloud (15 minutes)</b>		
<b>The Louisiana Purchase</b>		
<b>Discussing the Read-Aloud (15 minutes)</b>		
<b>Comprehension Questions</b>		
<b>Word Work: Clever</b>		
 <b>Complete Remainder of the Lesson Later in the Day</b>		

Exercise	Materials	Details
<b>Extensions (20 minutes)</b>		
<b>Multiple Meaning Word Activity: Letter</b>	Poster 3M (Letter)	
<b>Syntactic Awareness Activity: Sentence Types</b>	Punctuation Marks; Images 4A-3 and 4A-10	
<b>Vocabulary Instructional Activity: Double</b>	Image 4A-2; counting blocks; various classroom objects	
	Instructional Master 4B-1; drawing paper, drawing tools; scissors; glue or tape	<b>Note:</b> You may wish to assemble the puzzle in front of the class first. Then have students make their own puzzles during the Pausing Point.
<b>Explorer’s Journal #3</b>	Instructional Master 4B-2	

**Advance Preparation**

Make a large Idea Web for New Orleans. Record student responses to the question: “Why did President Jefferson want to buy New Orleans from France?”

➤ Above and Beyond: Make a copy of Instructional Master 3A-1 for students who are ready to complete this web on their own.

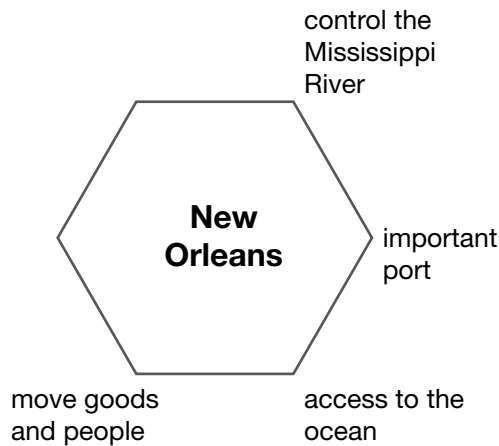

For the Vocabulary Instructional Activity, use counting blocks and various classroom objects (e.g., crayons, markers, paper clips) to help students understand the concept of double, or twice as much or many. Make copies of Instructional Master 4B-1 for each student. Students will create a puzzle of the United States that shows how the Louisiana Purchase made the United States

double in size. Prepare a class example of the puzzle to use during the activity; be sure that the puzzle pieces are colored in.

Make a copy of Instructional Master 4B-2 for each student. This will be the third page of the students' *Explorer's Journal*. They will write a letter to Thomas Jefferson about Napoleon's offer.





# The Louisiana Purchase

4<sub>A</sub>

**Note:** Introducing the Read-Aloud may have activity options that exceed the time allocated for this part of the lesson. To remain within the time periods allocated for this portion of the lesson, you will need to make conscious choices about which activities to include based on the needs of your students.

## ***Introducing the Read-Aloud***

**10** minutes

### **Where Are We?**

**5** minutes

Review with students the four cardinal directions: north, east, south, and west. Point to each letter taped onto the map in Lesson 2 and have students repeat the direction each letter represents. You may wish to review using a mnemonic device, such as “Never Eat Soggy Waffles.”

Have students point out the Mississippi River and the Rocky Mountains on the U.S. map. Remind students that during the time when Thomas Jefferson was president, the United States was the land east of the Mississippi River. Then ask students to point to the *mouth* of the Mississippi River, and the city of New Orleans.

Finally, have students point out the Appalachian Mountains. Remind students of Daniel Boone’s Wilderness Road and how it allowed people to expand farther west past the Appalachians. This continued to displace many Native Americans already living in the area, and forced them to leave their homes once again and move even further west.

### **What Have We Already Learned?**

**5** minutes

Review with students the read-aloud they heard previously, emphasizing that New Orleans and the area west of the Mississippi River was not part of the United States at the time the previous read-aloud took place. Make sure that students understand why President Jefferson wanted to buy New Orleans

from Napoleon and France. You may wish to ask the following questions:

- Why was the Mississippi River so important? (to move goods from land along the river to the ocean, and then to other people who wanted to buy them)
- Why did Thomas Jefferson want to buy the city of New Orleans from Napoleon and France? (for control of the Mississippi River)
- Who did Thomas Jefferson decide to send to France to talk with Napoleon about buying New Orleans? (his friend James Monroe)

### Setting

5 minutes

On a world map, point to England and ask students how the Pilgrims and other English settlers who first came to North America traveled there. (by boat) Remind them of how long the journey took on the Mayflower and how happy the Pilgrims were to finally reach land.

Now point to the country of France. Explain to students that the setting of today's read-aloud—or where it takes place—is France, where James Monroe traveled in order to talk to Napoleon. Explain that in order for James Monroe to travel from the United States to France, he had to travel by boat, which could take a few weeks or even a month. Trace the path a ship would have traveled from the United States to France.

### Vocabulary Preview

5 minutes

#### *Purchase*



#### ← Show image 4A-2: Map of the early United States

1. In today's read-aloud you will hear Thomas Jefferson ask James Monroe to go to France to *purchase* New Orleans.
2. Say the word *purchase* with me three times.
3. When you purchase something, you buy it.
4. Maria had saved enough money to purchase the book she wanted from the book fair.  
Jeremy's family went to the grocery store to purchase food for the week.

5. Have you ever purchased or helped someone purchase something? What did you purchase?

### ***Territory***

1. The land between the Mississippi River and the Rocky Mountains was called the Louisiana *Territory*.
2. Say the word *territory* with me three times.
3. A territory is a large area of land ruled by the government of another country.
4. [Point to the Louisiana Territory on the image. Point out how the city of New Orleans was part of the Louisiana Territory.] Which country do you think owned the Louisiana Territory? (France owned the Louisiana Territory.)
5. Is this territory large or small? What is to the east of this territory? What is to the west of this territory? Besides the French settlers, who else was living in the Louisiana Territory and had been living there for a long time? (Native Americans)

### **Purpose for Listening**

---

Tell students to listen to find out if James Monroe was able to buy the city of New Orleans from Napoleon for the United States.



## The Louisiana Purchase

### ← Show image 4A-1: Making plans

James Monroe sat at a desk in his hotel room in France. Monroe had been sent to France by the president of the United States, Thomas Jefferson.



### ← Show image 4A-2: Map of the early United States

Remember, France owned the city of New Orleans, which was near the place where the mighty Mississippi River flowed into the sea.<sup>1</sup> Whoever controlled New Orleans decided which ships passed up and down the river. The land on the east side of the river was owned by the United States. The land on the west side of the river was owned by France.<sup>2</sup> President Jefferson had told James Monroe, “I want you to go to France and offer to **purchase**<sup>3</sup> the city of New Orleans from Napoleon. Napoleon needs money to buy supplies for his soldiers and sailors, who are fighting in a series of wars. If he will sell New Orleans to us, he will receive the money he needs, and we will gain control of the Mississippi River.”

1 What is that area of the river called? (mouth)

2 [Point to the United States in orange and the Louisiana Territory in green on the map as you read.]

3 or buy



### ← Show image 4A-3: James Monroe and Napoleon Bonaparte

James Monroe met with Napoleon in the French emperor's palace in Paris, France. This palace was very different from the house in which President Thomas Jefferson lived in Washington, D.C.

Monroe thought to himself, “President Jefferson's home certainly is different from Napoleon's home. Napoleon lives in a grand palace with fine wooden floors half-covered in thick carpets. The walls are bright with expensive wallpapers, and the furniture probably cost a lot of money. When Napoleon is dressed in the fanciest clothes and sits on that throne, he talks and everyone else listens because they are afraid of his power, and because they hope he will do favors for them.”<sup>4</sup>

4 [Remind students that Napoleon was an emperor and had powers like a king.]



← **Show image 4A-4: Thomas Jefferson**

5 or large house

6 Monroe thinks that President Jefferson is very smart.

7 How are emperors and presidents different?

“But there are no thrones for Thomas Jefferson and no royal uniforms to make him look special. Sometimes visitors to the presidential **mansion**<sup>5</sup> don’t even recognize President Jefferson. They think he is one of the servants until they are introduced to him. When he starts to speak, however, everyone listens, but not because they are afraid of him. They listen because he is a **brilliant** man with wonderful ideas.<sup>6</sup> He doesn’t need thrones or royal robes in order for people to realize that he is a great man.”<sup>7</sup>



← **Show image 4A-5: Napoleon Bonaparte**<sup>8</sup>

8 [Have students compare this picture with image 4A-4 (Thomas Jefferson).]

9 *Clever* means smart and able to solve problems quickly.

“Well,” James Monroe thought, “I suppose I should be fair. Napoleon may not be my sort of person, but he is very **clever** once you are talking seriously with him; and he is about to do a great favor for the United States.”<sup>9</sup>



← **Show image 4A-6: Monroe and Napoleon**<sup>10</sup>

10 [Point out Napoleon and Monroe in the picture.]

Then, Napoleon finally spoke to Monroe, “I have thought over your president’s offer to buy the city of New Orleans. I have decided that selling New Orleans to the United States of America will not bring me as much money as I need.



← **Show image 4A-7: Map of the early United States**

11 [Point to the green area on the map that represents the Louisiana Territory, and explain that the word *territory* means a large area of land.]

“Instead, I will sell you New Orleans *and* all the lands owned by France between the Mississippi River and the Rocky Mountains, which is called the Louisiana **Territory**.<sup>11</sup> We will sell this land to you at a fair price.”<sup>12</sup>

12 Did Napoleon just want to sell New Orleans? What did he want to sell?

Hearing this, Monroe realized with a shock, “That is as much land as there is already in the *entire* United States of America! Overnight, we could have a nation twice as big as it is right now!”<sup>13</sup>

13 Do you think Monroe was excited or disappointed by Napoleon’s suggestion? How do you know?



← **Show image 4A-8: James Monroe and Napoleon Bonaparte**

Somehow Monroe had kept himself calm enough to answer Napoleon. “Your Majesty, this is indeed a marvelous opportunity. I cannot accept your offer, however, until I present it to President Jefferson and receive his answer. I will write to him at once.”

In Monroe’s time, there was no phone or email, so Monroe had to write a letter to Jefferson.<sup>14</sup> The letter would have to travel over the ocean in the same kind of ship that Monroe had traveled on when he first came to France. It would take a few weeks for Jefferson to get Monroe’s letter and even longer for Monroe to get Jefferson’s answer.

14 Here, the word *letter* means a written message to someone. The word *letter* also has other meanings. The word *letter* can also mean one of the symbols of the alphabet.



← **Show image 4A-9: Monroe writing to Jefferson**

James Monroe picked up his pen. “I need to finish my letter to President Jefferson,” he thought, “and then I can send it to him by the first ship sailing across the ocean to the United States. When he reads it, the president is going to be very surprised.”<sup>15</sup>

15 Why did Monroe think that Jefferson would be surprised?



← **Show image 4A-10: Jefferson reading Monroe’s letter**

Just as Monroe had expected, Thomas Jefferson was amazed when he read that letter. Jefferson thought, “This is even better than I could have imagined! Not only will we be buying the city of New Orleans, but also the entire Louisiana Territory. The United States will double in size! I will write back to James Monroe at once, telling him to purchase the Louisiana Territory for the United States.” He smiled. “The timing could not be better.” Then President Jefferson picked up his pen and began the letter instructing Monroe to seal the bargain with France, a bargain that would double the size of the United States of America.<sup>16</sup>

16 *Seal the bargain* means that Jefferson wanted Monroe to accept Napoleon’s offer and buy the Louisiana Territory. [Tell students that when the United States bought the Louisiana Territory from France, it was called the Louisiana Purchase.]

## Comprehension Questions

10 minutes

If students have difficulty responding to questions, reread pertinent passages of the read-aloud and/or refer to specific images. If students give one-word answers and/or fail to use read-aloud or domain vocabulary in their responses, acknowledge correct responses by expanding students' responses using richer and more complex language. Ask students to answer in complete sentences by asking them to restate the question in their responses.

1. *Literal* Who did James Monroe meet in France in order to discuss the purchase of the city of New Orleans? (James Monroe met with Napoleon to discuss the purchase of the city of New Orleans.)
2. *Literal* Did Napoleon want to sell New Orleans to the United States? (Yes)  
What else did Napoleon want to sell to the United States? (Napoleon wanted to sell the Louisiana Territory to the United States.)



← **Show image 4A-2: Map of early America**

3. *Literal* Point to the area of land called the Louisiana Territory, which the United States bought from France. (Students should point to the area between the Mississippi River and the Rocky Mountains.)
4. *Literal* What was the Louisiana Purchase? (The Louisiana Purchase was the land called the Louisiana Territory that the United States bought from France.)
5. *Inferential* Was the Louisiana Territory a lot of land or a little land? (The Louisiana Territory was a lot of land.) How do you know? (We know that it was a lot of land because it doubled the size of the United States at that time.)

[Please continue to model the *Question? Pair Share* process for students, as necessary, and scaffold students in their use of the process.]

6. *Evaluative What? Pair Share:* Asking questions after a read-aloud is one way to see how much everyone has learned. Think of a question you can ask your neighbor about the read-aloud that starts with the word *what*. For example, you could ask, “What did you learn about in today’s read-aloud?” Turn to your neighbor and ask your *what* question. Listen to your neighbor’s response. Then your neighbor will ask a new *what* question, and you will get a chance to respond. I will call on several of you to share your questions with the class.
7. After hearing today’s read-aloud and questions and answers, do you have any remaining questions? [If time permits, you may wish to allow for individual, group, or class research of the text and/or other resources to answer these questions.]

### **Word Work: Clever**

5 minutes

1. In the read-aloud you heard James Monroe think, “Napoleon may not be my sort of person, but he is very *clever* once you are talking seriously with him.”
2. Say the word *clever* with me.
3. *Clever* describes someone or something who is smart and able to solve problems quickly.
4. Thomas Jefferson was clever to ask Napoleon if he could buy New Orleans from France, because he knew Napoleon needed money.
5. What is something a clever person might do?  
[Prompt students by asking whether certain actions are clever. For example, you could ask, “Is wandering away from your parents at the store a clever thing to do?” Ask two or three students. If necessary, guide and/or rephrase students’ responses: “A clever person . . .”]
6. What’s the word we’ve been talking about?



Use a *Synonyms and Antonyms* activity for follow-up. Directions: I am going to say some words that are either a synonym, or similar to, or an antonym, or an opposite of, *clever*. If it is a synonym, say, “That is clever.” If it is an antonym, say, “That is not clever.”

- foolish (That is not clever.)
- smart (That is clever.)
- intelligent (That is clever.)
- silly (That is not clever.)
- unwise (That is not clever.)
- talented (That is clever.)
- quick thinking (That is clever.)



**Complete Remainder of the Lesson Later in the Day**

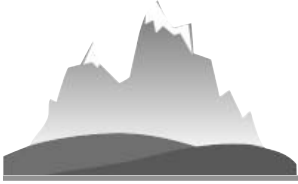

# The Louisiana Purchase

4<sub>B</sub>

**Note:** Extensions may have activity options that exceed the time allocated for this part of the lesson. To remain within the time periods allocated for this portion of the lesson, you will need to make conscious choices about which activities to include based on the needs of your students.

## Extensions

20 minutes

### ↔ Multiple Meaning Word Activity

5 minutes

#### *Sentence in Context: Letter*

**Note:** You may choose to have students hold up one or two fingers to indicate which image shows the meaning being described, or have a student walk up to the poster and point to the image being described.

1. [Show Poster 3M (Letter).] In the read-aloud you heard, “In Monroe’s time, there was no phone or email, so Monroe had to write a *letter* to Jefferson.” Here *letter* means a written message to someone. Which picture shows this type of letter?
2. A letter is also one of the symbols in our alphabet. Which picture shows this type of letter?
3. Now with your partner, make a sentence for each meaning of *letter*. Remember to use complete sentences. I will call on some of you to share your sentences.

### ↔ Syntactic Awareness Activity

5 minutes

#### *Sentence Types*

**Note:** The purpose of these syntactic activities is to help students understand the direct connection between grammatical structures and the meaning of text. These syntactic activities should be used in conjunction with the complex text presented in the read-alouds. There may be variations in the sentences created by your class.

Allow for these variations, and restate students' sentences so that they are grammatical. If necessary, have students repeat the sentence after you.

Please change the inflection of your voice to match the punctuation of the sentences you read aloud. Have students hold up the end punctuation for the sentences.



← **Show image 4A-3: James Monroe and Napoleon Bonaparte**

1. Every day we use different types of sentences as we talk to others. We use sentences that give information, ask questions, or shout or exclaim something exciting.
2. One type of sentence we use is to tell others information. The read-aloud told us, “Monroe met with Napoleon, the emperor of France.”  
[Hold up the period.] This sentence ends in a period because it gives information. You say it in a regular tone of voice. Now you try! I am going to say two sentences. Hold up the period when you hear me say a sentence that gives information.
  - Napoleon lives in a grand palace!
  - Napoleon lives in a grand palace.
3. Another type of sentence we use is to ask questions. In the read-aloud you heard Monroe ask Napoleon, “Will you sell New Orleans to the United States?”  
[Hold up the question mark.] This sentence ends in a question mark because it asks a question. You change the tone of your voice when you ask a question, sometimes by making the sound of your voice become higher at the end of the sentence.  
Now you try! I am going to say two sentences. Hold up the question mark when you hear me say a sentence that asks a question.
  - Napoleon wanted to sell the Louisiana Territory?
  - Napoleon wanted to sell the Louisiana Territory.



← **Show image 4A-10: Jefferson reading Monroe's letter**

4. Another type of sentence we use is to let others know we are very excited about something. In the read-aloud, Thomas Jefferson thought, "This offer is even better than I could have imagined!"  
[Hold up the exclamation point.] This sentence ends in an exclamation point because it expresses excitement.  
Now you try! I am going to say two sentences. Hold up the exclamation point when you hear me say a sentence that exclaims something.
  - The Louisiana Purchase made the United States double in size!
  - The Louisiana Purchase made the United States double in size.
5. What are the three types of sentences we use? What kind of punctuation do we use for each type of sentence? (sentences that give information/period; sentences that ask questions/question mark; sentences that exclaim something/exclamation point)

↔ **Vocabulary Instructional Activity**  
**(Instructional Master 4B-1)**

10 minutes

**Word Work: Double**



← **Show image 4A-2: Map of the early United States**

1. In the read-aloud you heard that with the purchase of the Louisiana Territory, the United States would *double* in size.
2. Say the word *double* with me three times.
3. *Double* means two times as much. [Point out the orange part of the map, the area of the United States before the Louisiana Purchase. Then point to the green portion of the map, the Louisiana Territory, an area that belonged to France.] Buying the Louisiana Territory made the size of the United States double.  
*Double* also means twice the amount or number. [Hold up three markers, then add three more markers.] I just made the number of markers double.

4. The school plans to remodel the library so that the area of the library will double. Does that mean the library will become smaller or larger?  
Juan’s mother made him wear double layers of clothes on cold, winter days. Does that mean Juan wears more clothes or less clothes?
5. [Draw a rectangle on the board.] Tell me if I have made this rectangle double. [Continue to make the rectangle larger and larger until it has doubled in size.]  
[Hold up two of the same objects.] Tell me if I have made the number of objects double. [Continue to add objects until the number has doubled.]
6. What’s the word we’ve been talking about?  
Use *The Louisiana Purchase Puzzle* activity for follow-up. Directions: Remember, when Jefferson purchased the Louisiana Territory, the United States became much bigger—it doubled! I will use this puzzle to show you how the land of the United States became double in size.
  - [Hold up the puzzle piece of the United States before the purchase of the Louisiana Territory.] This piece represents the size of the United States before the purchase of the Louisiana Territory. I am placing this piece inside the outline of the United States. How big does the United States look?
  - [Hold up the puzzle piece of the Louisiana Territory.] This piece represents the Louisiana Territory. I am placing this piece inside the outline of the United States, to the west of the other puzzle piece. How big does the United States look now? Did it double in size?

### Explorer’s Journal #3 (Instructional Master 4B-2)

15 minutes

- Go back through the Flip Book images from the read-aloud, and have students briefly retell the story. Make sure students understand that Napoleon not only wanted to sell New Orleans to the United States, he wanted to sell the whole Louisiana Territory.

- Tell students to pretend that they are James Monroe writing to Thomas Jefferson about Napoleon’s offer.
  - First, they should think about how James Monroe felt as he wrote the letter. Did he think Napoleon’s offer was a good one? What could he write to Jefferson to convince him to buy or not to buy the Louisiana Territory?
  - Next, they should write an introductory sentence telling Jefferson about the offer.
  - Then, they should write several sentences about whether Jefferson should buy the Louisiana Territory.
  - Finally, students should share their writing with their partner or home-language peers.



# Pausing Point



## **Note to Teacher**

---

You should pause here and spend one day reviewing, reinforcing, or extending the material taught thus far.

You may have students do any combination of the activities listed, but it is highly recommended that you use the Mid-Domain Student Performance Task Assessment to assess students' knowledge of frontier exploration. The other activities may be done in any order. You may also choose to do an activity with the whole class or with a small group of students who would benefit from the particular activity.

## **Core Content Objectives Up to This Pausing Point**

---

Students will:

- ✓ Recall basic facts about Daniel Boone
- ✓ Describe Daniel Boone as a trailblazer
- ✓ Identify what the Wilderness Road refers to
- ✓ Locate the Appalachian Mountains on a map
- ✓ Locate the Mississippi River on a map

## **Student Performance Task Assessment**

---

### **10 Map Assessment (Instructional Master PP-1)**

---

**Materials: brown, blue, and orange crayons or markers**

Directions: Find the Appalachian Mountains and color them brown. Find the Mississippi River and color it blue. Find the area that was the United States before the Louisiana Purchase and color it orange.

### **10 Frontier Explorers: True or False? (Instructional Master PP-2)**

---

Directions: I am going to read some sentences to you. If my sentence is correct or true, circle the letter 'T.' If my sentence is not correct or false, circle the letter 'F.' I will say each sentence

two times.

1. The United States has always been as large as it is today. (F)
2. Daniel Boone was an excellent hunter. (T)
3. Daniel Boone never found a pass through the Appalachian Mountains. (F)
4. Daniel Boone blazed the Wilderness Trail by himself. (F)
5. Thomas Jefferson and James Monroe were good friends. (T)
6. At the time of the read-alouds, Napoleon was the emperor of France. (T)
7. At the time of the read-alouds, France owned the land east of the Mississippi River. (F)
8. The U.S. and France had a big war over New Orleans. (F)
9. The Louisiana Territory went all the way to the Pacific Ocean. (F)
10. The Louisiana Purchase doubled the size of the United States. (T)

## ***Activities***

---

### **The Louisiana Purchase Puzzle**

---

**Materials: Instructional Master 4B-1; scissors, tape or glue**

If students have not had an opportunity to make their own Louisiana Purchase Puzzle, have them make one at this time. Remind students that the Louisiana Purchase doubled the size of the United States.

Have students color the puzzle piece of the United States before the Louisiana Purchase in one color and paste it onto the correct spot within the outline of the United States. Then have students color the puzzle piece of the Louisiana Territory in another color and paste it onto the correct spot within the outline of the United States.

Ask: “Does it look like the Louisiana Purchase doubled the size of the United States?”



## The Appalachian Mountains

---

### **Materials: Map of the United States**

Help students locate and identify the Appalachian Mountains. Discuss with students the problems the Appalachian Mountains presented to those who wanted to move west.

## Image Review

---

Show the Flip Book images from any read-aloud again, and have students retell the read-aloud using the images.

## Image Card Review

---

### **Materials: Image Cards 1–5**

Hold Image Cards 1–5 in your hand, fanned out like a deck of cards. Ask a student to choose a card but not show it to anyone else in the class. The student must then perform an action or say a clue about the picture s/he is holding. For example, for Columbus, a student may say, “I searched for a route to India but landed in the Americas instead. Who am I?” The rest of the class will guess what or who is being described. Proceed to another card when the correct answer has been given. Encourage students to use content-specific vocabulary and tier two words during this activity.

## Domain-Related Trade Book or Student Choice

---

### **Materials: Trade book**

Read a trade book to review a particular event; refer to the books listed in the Introduction. You may also choose to have the students select a read-aloud to be heard again.

## You Were There: The Wilderness Road

---

Have students pretend that they were with Daniel Boone when he made the Wilderness Road. Ask students to describe what they saw and heard. For example, students’ may talk about all of the trees and plants that Daniel Boone had to cut down and how that may have sounded or what it may have looked like.

## **Class Book: Daniel Boone**

---

### **Materials: Drawing paper, drawing tools**

Tell the class or a group of students that they are going to make a class book to help them remember what they have learned thus far in this domain. Have students brainstorm important information about the adventures of Daniel Boone. Have each student choose one idea to draw a picture of and then write a caption for the picture. Bind the pages to make a book to put in the class library for students to read again and again. You may choose to add more pages upon completion of the entire domain before binding the book.

## **On Stage: The Adventures of Daniel Boone**

---

**Note:** Students may require additional guidance in order to complete this activity.

Have a group of students plan and then act out one of the adventures they heard about Daniel Boone. (building the Wilderness Road, etc.)

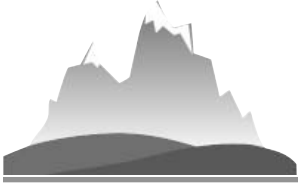

# Lewis and Clark

# 5

## ✓ **Lesson Objectives**

---

### **Core Content Objectives**

---

Students will:

- ✓ Locate the Mississippi River on a map
- ✓ Locate the Rocky Mountains on a map
- ✓ Identify and locate the Louisiana Territory on a map
- ✓ Explain the significance of the Louisiana Territory and Purchase
- ✓ Explain the reasons that Lewis and Clark went on their expedition
- ✓ Explain that there were many, many Native American tribes living in the Louisiana Territory before the Lewis and Clark expedition

### **Language Arts Objectives**

---

The following language arts objectives are addressed in this lesson. Objectives aligning with the Common Core State Standards are noted with the corresponding standard in parentheses. Refer to the Alignment Chart for additional standards addressed in all lessons in this domain.

Students will:

- ✓ Draw and write sentences about which one of Lewis and Clark's three tasks they think will be easiest and which will be most difficult, supplying reasons for their opinions (W.1.1)
- ✓ Make personal connections to a map of Lewis and Clark's route by creating a map of their route from home to school (W.1.8)
- ✓ With assistance, create and interpret a timeline of the settlement of North America (W.1.8)
- ✓ Share writing with others

## Core Vocabulary

**assistant, n.** A helper

*Example:* The teacher had an assistant to help in the classroom.

*Variation(s):* assistants

**brave, adj.** Showing courage and doing something even if it may be dangerous or frightening

*Example:* Tanya was brave when she decided to learn how to swim, even though she was afraid of water.

*Variation(s):* braver, bravest

**co-captain, n.** Someone who shares the position and responsibility as leader

*Example:* Clark was honored to be chosen as co-captain for the expedition.

*Variation(s):* co-captains

Vocabulary Chart for Lewis and Clark			
Core Vocabulary words are in <b>bold</b> .			
Multiple Meaning Word Activity word is <u>underlined&gt;</u> .			
Vocabulary Instructional Activity words have an asterisk (*).			
Suggested words to pre-teach are in <i>italics&gt;</i> .			
Type of Words	Tier 3 Domain-Specific Words	Tier 2 General Academic Words	Tier 1 Everyday-Speech Words
<b>Understanding</b>	<b>assistant</b> <b>co-captain</b> explorer	<b>brave*</b> explore peace purchased <i>route</i> tasks team unexplored	animals friends leader ocean river
<b>Multiple Meaning</b>		complete help reasons sample	land letter map plants trip water
<b>Phrases</b>	all-water route Louisiana Territory Meriwether Lewis Mississippi River Missouri River Native Americans Pacific Ocean William Clark		
<b>Cognates</b>	<b>asistente</b> explorador(ora)	explorar paz <i>ruta</i> inexplorado razones	animales océano mapa plantas

**Note:** Introducing the Read-Aloud and Extensions may have activity options that exceed the time allocated for that part of the lesson. To remain within the time periods allocated for each portion of the lesson, you will need to make conscious choices about which activities to include based on the needs of your students.

Exercise	Materials	Details
<b>Introducing the Read-Aloud (10 minutes)</b>		
<b>Direction Review</b>	Image 5A-1; Cardinal Directions activity page; U.S. map with cardinal directions	Use image 5A-1 and the Cardinal Directions activity page for students to ask and answer questions about the map using cardinal directions. For example, “In what part of the United States are the Appalachian Mountains located?”
<b>What Have We Already Learned?</b>	<i>Frontier Explorers</i> Map; U.S. map	Review how America had grown in size and how the Louisiana Purchase doubled the size of America. Be sure that students understand that the area in orange belonged to the United States. Remind students that the Native Americans lived on that land for a long time before the English or French settlers came to North America. Show how the Native Americans were forced to move further and further west.
	Image Card 9 (Louisiana Purchase); class timeline	Add Image Card 9 to the timeline. Later, students will add this image to their timelines.
<b>Vocabulary Preview: Tasks, Route</b>	Instructional Master 5A-1 (Tasks Checklist)	Introduce students to this checklist. Students will fill in the three tasks during the read-aloud and refer back to this check-list throughout the rest of this domain.
	drawing paper, drawing and writing tools	Students will draw the route they take to come to school. You may wish to make this an oral activity to save time.
<b>Purpose for Listening</b>	Image 5A-7	Introduce the main characters, Meriwether Lewis (brown hair) and William Clark (red hair).

Exercise	Materials	Details
<b>Presenting the Read-Aloud (15 minutes)</b>		
Lewis and Clark	chart paper, chalkboard, or whiteboard, writing tools	Record which kinds of animals and plants might be found in the unexplored western lands.
	Tasks Checklist	Have students record the task in the row with its related image.
<b>Discussing the Read-Aloud (15 minutes)</b>		
Comprehension Questions	Tasks Checklist	Use the checklist to answer Question #4.
Word Work: Brave		
 <b>Complete Remainder of the Lesson Later in the Day</b>		
<b>Extensions (20 minutes)</b>		
Timeline	Image Card 10 (Lewis and Clark); timeline	Add Lewis and Clark to the timeline. Stress that at the time of this read-aloud, the United States had doubled in size because of the Louisiana Purchase, and President Jefferson chose Meriwether Lewis to explore the new land.
Explorer's Journal #4	Image Cards 11–13; Instructional Master 5B-1	
<b>Take-Home Material</b>		
Family Letter	Instructional Masters 5B-2 and 5B-3	

### **Advance Preparation**

Make copies of Instructional Master 5A-1 so that each student has a checklist. This will be the students' Tasks Checklist, which they will fill in during the read-aloud and refer to throughout the rest of this domain.

Make a copy of Instructional Master 5B-1 for each student. This will be the fourth page of the students' Explorer's Journal. They will draw and write about either the hardest or easiest task President Jefferson gave to Lewis and Clark.

### **Notes to Teacher**

The read-aloud is shorter than usual. You may wish to make the read-aloud more interactive by having students imagine what

kinds of animals and plants Lewis and Clark might find in the unexplored western lands. In addition, have students fill in their Task Checklists during the read-aloud and predict whether Lewis and Clark will accomplish these three tasks.

The remainder of this domain is about Lewis and Clark and the Corps of Discovery's expedition through the Louisiana Purchase and beyond. Refer to these additional web resources for information, images, and teaching ideas to present their expedition in an accurate and engaging manner:

<http://www.nationalgeographic.com/lewisandclark/index.html>

<http://www.monticello.org/site/families-and-teachers/thomas-jefferson-and-lewis-and-clark-expedition>

<http://www.pbs.org/lewisandclark/index.html>

You may wish to have the class or small groups participate in the online activities related to Lewis and Clark's expedition:

<http://www.usmint.gov/kids/games/lewisclarkadventure/>

<http://www.nationalgeographic.com/west/>

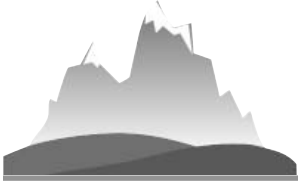

# Lewis and Clark

5<sub>A</sub>

**Note:** Introducing the Read-Aloud may have activity options that exceed the time allocated for this part of the lesson. To remain within the time periods allocated for this portion of the lesson, you will need to make conscious choices about which activities to include based on the needs of your students.

## ***Introducing the Read-Aloud***

**10** minutes

### **Direction Review**

**5** minutes

Review with students the four cardinal directions: north, east, south, and west. Point to each letter taped onto the map in lesson 2 and have students repeat the direction each letter represents. You may wish to review using a mnemonic device, such as “Never Eat Soggy Waffles.”



### **What Have We Already Learned?**

**10** minutes

#### ← **Show image 5A-1: Map of the Louisiana Purchase**

Refer to the timeline as you review. Point to the area representing the original colonies, and remind students that the read-alouds they have heard over the last several days describe how America grew in size from the original thirteen colonies to a much larger country.

Review what students learned about Daniel Boone and other settlers’ desire to move west of the Appalachian Mountains.

Discuss with students that Native Americans had already been living in North America for thousands of years when settlers arrived to North America from Europe. As these settlements became colonies, many Native Americans were forced to move away from their family lands in what is now the eastern United States. Some moved west over the Appalachian Mountains.

The Wilderness Road that Daniel Boone helped create made it easier for pioneer families to move west over the Appalachian



Mountains, which in time expanded the area of the United States. This displaced many Native Americans already living in the area, or forced them to leave their homes and move even further west.

Now point to the image of Thomas Jefferson on the timeline, and ask students to identify him and the role he played in increasing the size of the United States as a country. Prompt students as needed to recall that President Jefferson wanted to purchase the city of New Orleans from the country of France so that Americans could continue to use the Mississippi River for travel and trade.

Point to and have students identify the Mississippi River and the Rocky Mountains. Point to the land area between the Mississippi and the Rocky Mountains, and ask students what this area was called at the time Jefferson was president and how the United States acquired this land. Now place Image Card 9 (the Louisiana Purchase) on the timeline after Image Card 8 (Thomas Jefferson).

## Vocabulary Preview

5 minutes

### **Tasks (Instructional Master 5A-1)**

1. In today's read-aloud you will hear about three *tasks* that President Jefferson wanted Lewis and Clark to do.
2. Say the word *tasks* with me three times.
3. Tasks are different things that need to be done.
4. The teacher gave each student different tasks for their class project.
5. Look at your Tasks Checklist. Can you predict what the three tasks might be?

### **Route**

1. In today's read-aloud, you will hear that President Jefferson is looking for a special *route* through the new land he purchased.
2. Say the word *route* with me three times.
3. A route is a way to get from one place to another place.
4. Tamara remembers the route from her home to school

because she takes that way everyday.

5. Which route do you take to get to school? What do you see on that route? Do you walk, take a subway or bus, or drive to school? Draw a map that shows where you live and where school is. Connect your home to your school by drawing a red line between the two places. This red line is the route you take to get to school. Include things you see on your way to school.

### **Purpose for Listening**

---

Remind students that in the last read-aloud, they learned that the United States purchased the Louisiana Territory from France. Tell students that not many people in the United States knew what was in the Louisiana Territory, just like not many people knew much about the land between the Appalachian Mountains and the Mississippi River before Daniel Boone went exploring there. Tell students to listen to find out who will explore the Louisiana Territory and what their tasks will be.



## Lewis and Clark

### ← Show image 5A-1: Map of the Louisiana Purchase

We learned last time about the Louisiana Purchase, when the United States government purchased the Louisiana Territory from France. Once the purchase of the Louisiana Territory was complete, President Thomas Jefferson wanted to send explorers to make maps of this new land and learn more about it.



### ← Show image 5A-2: Jefferson musing on the possibilities

Thinking about the Louisiana Territory, Jefferson wondered, “Is it possible that there are tigers or elephants living out there in those unexplored western lands? No one has explored enough to really know. Perhaps there are plants whose leaves could be used as medicines to help sick people, or which would be delicious to eat. My Native American friends who live there have brought me a few plants to study, but I am sure there must be more plants and animals which even they have not seen.”

Jefferson prepared to send explorers into the Louisiana Territory.

“I need the leader of these explorers to be someone I can trust, someone very **brave** and very smart.”<sup>1</sup>

1 A brave person is someone who shows courage and is not afraid to explore places that others have not already explored, even if it may be dangerous or frightening.



### ← Show image 5A-3: Meriwether Lewis

President Jefferson suddenly smiled. “Why, I know just the person for the job.”

He sat down and wrote a letter to his former **assistant**,<sup>2</sup> a man named Meriwether Lewis. Jefferson asked Meriwether Lewis if he would lead the team of explorers.

2 An assistant is a helper.



### ← Show image 5A-4: Lewis and Clark’s projected path on the Missouri River and beyond<sup>3</sup>

Jefferson had three reasons for wanting Lewis to explore the Louisiana Territory.<sup>4</sup>

3 [Share that the projected path is in red.]

4 [Point out the different landmarks on the map as you talk about them.]

Jefferson wrote to Lewis, “First, I want you to find out if there is an all-water route to the Pacific Ocean. Travel the Missouri River, which branches out to the west from the Mississippi River. The two big rivers meet at St. Louis, so you could start the trip along the Missouri from there. Perhaps the Missouri River flows all the way to the Pacific Ocean, or if it does not, maybe it connects to other rivers that do reach the Pacific Ocean. You can find out for us. Second, you can collect samples of plants and animals so that we will know what grows well in the lands we have just added to our nation. Third, you must also become friends with the Native Americans you meet. You will want to bring along presents for them so they will know you come to offer peace.”<sup>5</sup>

5 [Help students to restate the three reasons Jefferson wanted Lewis to explore the Louisiana Territory. You may wish to make a list on the board.]



← **Show image 5A-5: Lewis writing to Jefferson**

When Meriwether Lewis received the president’s letter, he was very excited. However, he was a thoughtful man. He wrote back, “I am very honored that you have asked me to do this, Mr. President, and I will do my very best for you and for our nation. With your permission, however, I will ask a friend of mine, William Clark, to help me with these tasks.



← **Show image 5A-6: William Clark**<sup>6</sup>

6 This is William Clark, Meriwether Lewis’s friend. [Point out that he has reddish hair.]

7 Lewis wanted to share the job of captain with Clark.

“William Clark and I became great friends when we served together in the army. He and I work well together. Clark is very good at drawing maps, identifying plants and animals, and he has a lot of experience with Native Americans. I would feel much more certain that we could do the things you ask if William Clark could accompany me as **co-captain.**”<sup>7</sup> President Jefferson agreed.



← **Show image 5A-7: Lewis and Clark preparing for the journey**

As Lewis and Clark prepared to start on their journey, they did not know that the dangers and wonders they were about to face together would make their friendship even stronger.<sup>8</sup>

8 What dangers and wonders do you think Lewis and Clark may find?

### Comprehension Questions

10 minutes

If students have difficulty responding to questions, reread pertinent passages of the read-aloud and/or refer to specific images. If students give one-word answers and/or fail to use read-aloud or domain vocabulary in their responses, acknowledge correct responses by expanding students' responses using richer and more complex language. Ask students to answer in complete sentences by asking them to restate the question in their responses.



← **Show image 5A-1: Map of the Louisiana Purchase**

1. *Literal* Point to the Louisiana Territory on the map. (Students should point to the land between the Mississippi River and the Rocky Mountains.)
2. *Inferential* Why did Thomas Jefferson want someone to explore the Louisiana Territory? (Thomas Jefferson wanted someone to explore the Louisiana Territory in order to learn more about it.)
3. *Literal* Who would explore the Louisiana Territory for Jefferson? (Lewis and Clark would explore the Louisiana Territory for Jefferson.)
4. *Literal* [Reread or paraphrase the paragraph where Jefferson explains to Lewis his three tasks.] What were the three things that Jefferson wanted Lewis to do on his trip? (Jefferson wanted Lewis to find an all-water route to the Pacific Ocean, collect samples of plants and animals, and make friends with the Native Americans.)
5. *Evaluative* Why were these three tasks important to the United States? (Answers may vary, but might include to help build the new country.)

[Please continue to model the *Think Pair Share* process for students, as necessary, and scaffold students in their use of the process.]

I am going to ask a few questions. I will give you a minute to think about the questions, and then I will ask you to turn to your

neighbor and discuss the questions. Finally, I will call on several of you to share what you discussed with your partner.

6. *Evaluative Think Pair Share:* Think about which civilization of people were already living on the land when the Louisiana Purchase was made. Do you think the Native Americans living on the land thought the Louisiana Purchase was fair? Why or why not? Do you think Lewis and Clark thought the Louisiana Purchase was fair? Why or why not? (Answers may vary.)
7. After hearing today's read-aloud and questions and answers, do you have any remaining questions? [If time permits, you may wish to allow for individual, group, or class research of the text and/or other resources to answer these questions.]

### Word Work: Brave

5 minutes

1. In the read-aloud you heard Jefferson say, "I need the leader of these explorers to be someone I can trust, someone very *brave* and very smart."
2. Say the word *brave* with me.
3. When someone is brave, it means he or she shows courage and does something even if it may be dangerous or frightening.
4. Tanya was brave when she decided to learn to swim, even though she was afraid of the water.
5. Can you think of a time when you did something brave? Try to use the word brave when you talk about it.  
[Ask two or three students. If necessary, guide and/or rephrase students' responses: "I was brave when . . ."]
6. What's the word we've been talking about?

Use a *Making Choices* activity for follow-up. Directions: I am going to say some sentences. If the person in my sentence was brave, say "S/he was brave." If the person in my sentence was not brave, say, "S/he was not brave."

- Daniel Boone explored the Appalachian Mountains, not knowing what kind of wild animals he might meet. (He was brave.)

- Joe was afraid of the troubles he might have if he moved west so he stayed on the east coast. (He was not brave.)
- Clara was a pioneer who loved adventure and to explore unknown places. (She was brave.)
- Michelle fell down on the ice but got right back up and continued to skate even though she was embarrassed. (She was brave.)
- Julian refused to go on the field to play the game because he did not want to lose. (He was not brave.)
- Sarah only wanted to do things that she knew she was good at. (She was not brave.)
- Roger stood up for himself by opening up how he felt to his teacher and parents about being bullied. (He was brave.)



### **Complete Remainder of the Lesson Later in the Day**



# Lewis and Clark

5<sub>B</sub>

**Note:** Extensions may have activity options that exceed the time allocated for this part of the lesson. To remain within the time periods allocated for this portion of the lesson, you will need to make conscious choices about which activities to include based on the needs of your students.

## Extensions

20 minutes

### Timeline

10 minutes

- Review information that is already on the timeline. Ask students: “What did Thomas Jefferson do that doubled the size of the United States?” Emphasize that Thomas Jefferson (Image Card 8) made the Louisiana Purchase (Image Card 9) by buying the land from France.
- Show Image Card 10 (Lewis and Clark). Ask students: “What did Thomas Jefferson ask Lewis and Clark to do?” (find an all-water route to the Pacific Ocean, record the different kinds of animals and plants they saw, and become friends with the Native Americans) Add Image Card 10 after the Louisiana Purchase. Tell students that at the time of today’s read-aloud, Jefferson asked Lewis and Clark to explore the new land he had purchased.
- Have students add images of the Louisiana Purchase and Lewis and Clark to their individual timelines.
- Have partner pairs explain the relationships between the items that they have on their timeline.
- Then have students write a sentence about what happened after the Louisiana Purchase on the back of their timelines, on the row labeled #3.



## Explorer's Journal #4 (Instructional Master 5B-1)

15 minutes

- Use Image Cards 11–13 to review the three tasks that Lewis and Clark needed to accomplish on their trip. As you show the class each Image Card, have them talk about the task demonstrated on the Image Card.

[Students may wish to use their Tasks Checklist. You may also wish to divide the class into three groups and have each group present the task represented on the Image Card to the class.]

- Tell students to pretend they are Lewis and Clark and are about to go on their journey.
  - First, they should think about which task seems like the easiest and which task seems like the hardest.
  - Next, they should choose one of the tasks to draw.
  - Then, they should write several sentences about whether this will be an easy or hard task and explain why.
  - Finally, students should share their drawings and writing with their partner or home-language peers.

## ***Take-Home Material***

---

### Family Letter

Send home Instructional Masters 5B-2 and 5B-3.

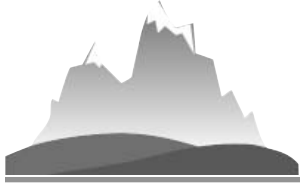

# Lewis and Clark: The Journey Begins

6

## ✔ **Lesson Objectives**

---

### **Core Content Objectives**

---

Students will:

- ✓ Locate the Mississippi River on a map
- ✓ Locate the Rocky Mountains on a map
- ✓ Identify and locate the Louisiana Territory on a map
- ✓ Explain the significance of the Louisiana Territory and Purchase
- ✓ Explain the reasons that Lewis and Clark went on their expedition
- ✓ Explain that there were many, many Native American tribes living in the Louisiana Territory before the Lewis and Clark expedition

### **Language Arts Objectives**

---

The following language arts objectives are addressed in this lesson. Objectives aligning with the Common Core State Standards are noted with the corresponding standard in parentheses. Refer to the Alignment Chart for additional standards addressed in all lessons in this domain.

Students will:

- ✓ Ask and answer *when* questions orally, requiring literal recall and understanding of the details and facts from “Lewis and Clark: The Journey Begins” (SL.1.2)
- ✓ Add drawings to descriptions of the student on an expedition to clarify ideas, thoughts, and feelings (SL.1.5)
- ✓ Share writing with others
- ✓ Evaluate and select read-alouds on the basis of personal choice for rereading

## Core Vocabulary

---

**communicate, v.** To share your thoughts and ideas with someone

*Example:* There are many ways to communicate with others; talking is one of them.

*Variation(s):* communicates, communicated, communicating

**diary, n.** A book or journal for writing personal thoughts and experiences

*Example:* Joy wrote about her day in her diary that she kept next to her bed.

*Variation(s):* diaries

**expedition, n.** A journey or trip that a group of people take for a special reason

*Example:* The class organized an expedition into the woods to observe the birds.

*Variation(s):* expeditions

**shelters, n.** Things that cover or protect people from the weather or danger

*Example:* When Daniel Boone was traveling along the Wilderness Road, he built shelters in the woods along the way.

*Variation(s):* shelter

**survive, v.** To stay alive

*Example:* The cactus will survive in the desert, even though there is not very much rain.

*Variation(s):* survives, survived, surviving

### Vocabulary Chart for Lewis and Clark: The Journey Begins

Core Vocabulary words are in **bold**.  
 Multiple Meaning Word Activity word is underlined.  
 Vocabulary Instructional Activity words have an asterisk (\*).  
 Suggested words to pre-teach are in *italics*.

Type of Words	Tier 3 Domain-Specific Words	Tier 2 General Academic Words	Tier 1 Everyday-Speech Words
<b>Understanding</b>	co-captains <b>expedition*</b> hunters/trappers keelboat/pirogue	brave <b>communicate</b> exploration language <i>skill</i> <b>survive</b>	<b>diary</b> food river
<b>Multiple Meaning</b>	<i>corps</i> <b>shelters</b>	settled supplies travel	foot
<b>Phrases</b>	<i>Corps of Discovery</i> frontier town Mississippi River Missouri River Native Americans Pacific Ocean St. Louis		
<b>Cognates</b>	<b>expedición*</b>	<b>comunicar</b> exploración	<b>diario</b>

**Note:** Introducing the Read-Aloud and Extensions may have activity options that exceed the time allocated for that part of the lesson. To remain within the time periods allocated for each portion of the lesson, you will need to make conscious choices about which activities to include based on the needs of your students.

Exercise	Materials	Details
<b>Introducing the Read-Aloud (10 minutes)</b>		
Where Are We?	Frontier Explorers Map, blue crayon or marker; U.S. map	Have students shade the Atlantic Ocean and the Pacific Ocean in blue. Point out that the Atlantic Ocean is on the east coast and that the Pacific Ocean is on the west coast.
What Have We Already Learned?	Image Cards 11–13; Tasks Checklist	Use the Tasks Checklist to review the three tasks President Jefferson gave Lewis and Clark. Ask whether any of the tasks have been finished or accomplished.
Vocabulary Preview: Corps of Discovery, Skills	Image Card 14 (Corps of Discovery); Instructional Master 6A-1 ( <i>Join the Corps of Discovery!</i> Flyer)	Introduce students to the Corps of Discovery, the group that traveled with Lewis and Clark.
Purpose for Listening		
<b>Presenting the Read-Aloud (15 minutes)</b>		
Lewis and Clark: The Journey Begins	U.S. map	
	<i>Join the Corps of Discovery!</i> Flyer	Have students make a list of skills the members of the expedition needed to have.
	Instructional Master 6A-2 (Supply Crate)	Have students draw and write about the supplies they think the explorers would need on their journey.
<b>Discussing the Read-Aloud (15 minutes)</b>		
Comprehension Questions	Supply Crate; <i>Join the Corps of Discovery!</i> Flyer	Use the flyer to answer Questions #1 and #2 respectively.
Word Work: Expedition	drawing paper, drawing and writing tools	
 <b>Complete Remainder of the Lesson Later in the Day</b>		

Exercise	Materials	Details
<b>Extensions (20 minutes)</b>		
Explorer's Journal #5	Image 6A-6; Instructional Master 6B-1	
Domain-Related Trade Book or Student Choice	trade book related to Lewis and Clark's expedition; drawing paper, drawing and writing tools	Trade book suggestions: Items 6–9, 13, and 15
	chart paper, chalkboard, whiteboard, sticky notes	

### **Advance Preparation**

Make a copy of Instructional Master 6A-1 for each student. This will be their *Join the Corps of Discovery!* Flyer. Students will fill in this flyer during the read-aloud.

Make a copy of Instructional Master 6A-2 for each student. Have students draw and write about the supplies they think the explorers would need on their journey.

Make a copy of Instructional Master 6B-1 for each student. This will be the fifth page of the students' *Explorer's Journal*. It is a diary entry where students pretend to be a member of the Corps of Discovery and will write down their feelings about beginning this expedition.

Find a trade book about Lewis and Clark to read aloud to the class.

### **Notes to Teacher**

The read-aloud is shorter than usual. You may wish to make the read-aloud more interactive by having students create a flyer to find people to join Lewis and Clark's expedition. In addition, have students draw and write about the supplies the explorers would need on their journey.



# Lewis and Clark: The Journey Begins

6A

**Note:** Introducing the Read-Aloud may have activity options that exceed the time allocated for this part of the lesson. To remain within the time periods allocated for this portion of the lesson, you will need to make conscious choices about which activities to include based on the needs of your students.

## ***Introducing the Read-Aloud***

**10** minutes

### **Where Are We?**

5 minutes

Help students locate the Atlantic Ocean, the Appalachian Mountains, the Mississippi River, the Rocky Mountains, and the Pacific Ocean on a map. In addition, have students color the Atlantic Ocean and Pacific Ocean blue. Point out that the Atlantic Ocean is on the east coast and the Pacific Ocean is on the west coast.

### **What Have We Already Learned?**

5 minutes

Remind students that they heard that Lewis and Clark would be leading the exploration of the Louisiana Territory. Ask students what Lewis and Clark's three tasks were on their trip. Use Image Cards 11–13 to help students review the tasks.

Then, ask students if they remember why Jefferson wanted the United States to have control of the Mississippi River. Remind students that at that time it was much easier to transport people and goods on a river than over land. Explain to students that, for the same reason, Lewis and Clark traveled on rivers as they explored the Louisiana Territory.

***the Corps (KOHR) of Discovery***

1. In today's read-aloud, you will hear about a group called the *Corps of Discovery*.
2. Say the name *Corps of Discovery* with me three times.
3. [Show Image Card 14 (Corps of Discovery.)] The Corps of Discovery was a part of the U.S. Army whose members joined Lewis and Clark to explore the land added to the United States as a result of the Louisiana Purchase.  
A corps is part of the military that does a special kind of work. A corps is also a group of people who do an activity together, such as volunteering.
4. The Corps of Discovery explored the western territory to the west of the Mississippi River.
5. Why do you think the group chosen to explore the western part of the United States was called the Corps of Discovery?

***Skills (Instructional Master 6A-1)***

1. Lewis and Clark wanted people in the corps to have special *skills* that would be useful to them in their journey.
2. Say the word *skills* with me three times.
3. Skills are the abilities to do work or activities that need special training and knowledge. Knowing different languages, being able to play a sport well, and being able to write well are examples of skills.
4. The people that Lewis and Clark chose to take with them on their trip had many different skills.
5. Look at this flyer. A flyer is similar to a poster that people pass out to give information or to advertise something. During the read-aloud, you will hear about some skills Lewis and Clark were looking for in the people they chose to take on the journey with them. What are some skills you think might be important to have in order to take this journey?  
Listen carefully to the read-aloud to see if any of these skills are mentioned in the read-aloud.



## **Purpose for Listening**

---

Ask students if they think that Lewis and Clark explored the Louisiana Territory and completed their three tasks all by themselves. Why or why not? Explain to students that Lewis and Clark gathered a group of people, known as the Corps of Discovery, to accompany and help them. Tell students to listen to find out what kinds of people Lewis and Clark looked for to help them.



## Lewis and Clark: The Journey Begins

### ← Show image 6A-1: Lewis and Clark preparing for their journey

Before they began their exploration of the Louisiana Territory, Meriwether Lewis traveled to Indiana to join William Clark and gather their team of explorers. Lewis explained, “As I wrote in my letters, Will, because the United States government is paying for this exploration, we will travel as members of the U.S. Army. I asked that we be made co-captains so we would have equal command over our men.”



### ← Show image 6A-2: Frontier town

Soon they traveled to the city of St. Louis, where the wide Missouri River flows into the even mightier Mississippi River.<sup>1</sup> St. Louis was a frontier town. Its streets and stores bustled with hunters and trappers who had chosen to live far beyond the more settled cities of the east.<sup>2</sup>

1 [Point to these locations on a U.S. map.]

2 Trappers are people who hunt and catch animals to use their fur for clothing and blankets.



### ← Show image 6A-3: Part of Lewis and Clark's team

The two captains knew that it would take courage, intelligence, and skill to reach the Pacific, so they looked for people who knew how to **survive**<sup>3</sup> in forests and on rivers and mountains. These people would need to know how to hunt and fish for food and build **shelters** in which they could stay warm, dry, and safe.<sup>4</sup> Some were Americans who had grown up in Virginia or Pennsylvania, and who had later moved farther west to live in Kentucky. Others were Canadians, from the country north of the United States, who spoke French as well as English.<sup>5</sup> The two captains finally put together a team of trusty men who were daring and brave enough for the **expedition**.<sup>6</sup>

3 or stay alive

4 There were no houses or hotels in the Louisiana Territory, so people had to be able to make their own shelters to sleep in.

5 [Show students each location on a map.]

6 An expedition is when a group of people travel together for some special reason, such as exploring.



← **Show image 6A-4: George Drouillard**

Among the men who joined Lewis and Clark’s group, one man stood out. He appeared before them one day dressed half in manufactured clothing and half in the animal skins favored by woodsmen. “I am George Drouillard (dru-YAR),” he told them. “I hear you are going all the way to the Pacific. Ask the others you have already hired about me. They all know me. I speak French, English, and some Native American languages, so I can help you **communicate** with your men and with many native people you meet.<sup>7</sup> I also know the hand sign languages used by Native Americans who live out on the great western plains. When different tribes meet, they use this sign language, since their spoken languages are not all the same. I can ask them about the country ahead, and help them understand that you have come in peace.”<sup>8</sup>

7 Communicating is sharing your thoughts with someone. Speaking is one form of communication.

8 Do you think George Drouillard would be helpful during the expedition?

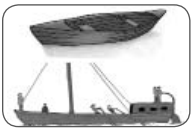

← **Show image 6A-5: Pirogue and keelboat**

Lewis and Clark had to gather supplies as well as people. They were going to need to take a lot of things with them on their trip.

They purchased some long, narrow canoes called “pirogues” (pi-ROHGS), and one larger, wider boat called a keelboat.<sup>9</sup> On the deck of the keelboat stood a little cabin that held supplies.

9 [Point to the pirogue and the keelboat in the picture.]

Riders in the pirogues moved their narrow boats forward using canoe paddles, but the keelboat had a sail. Moving the keelboat was slower and more difficult than moving a pirogue. When a strong enough wind was behind them, it pushed the keelboat along, but if there was no wind, the men had to take turns pushing and pulling it with poles and ropes.



← **Show image 6A-6: Setting out**

On Monday, May 14, 1804, the explorers were ready. They called themselves the *Corps* (KOHR) of *Discovery*.<sup>10</sup> Now they would leave St. Louis and travel west along the Missouri, as President Jefferson had requested. As one of them, Private John Whitehouse, wrote in his **diary** that day, “We . . . hoisted [our] sail, and set out in high spirits for the western expedition.”<sup>11</sup> At last they were on their way.

10 A corps is a group of people working together.

11 A diary is a book or journal for writing down thoughts and experiences.

### Comprehension Questions

10 minutes

1. *Evaluative* Imagine you were going with Lewis and Clark and you wouldn't be home for many months. What kinds of things do you think you would need to take with you? (You might need food, water, and clothes.)
2. *Inferential* The people that Lewis and Clark chose to take with them on their trip had many different skills. Name a few of their skills. (Some of the skills were survival skills, such as knowing how to hunt, fish, and build shelters, as well as language skills, such as the ability to speak many languages.) Why were these skills important? (They would have to find their own food, build their own shelters, and talk with Native Americans.)
3. *Inferential* Why did the Corps of Discovery travel up the river instead of on foot? (It was easier to travel and transport things on the river. There were no roads yet, so in order to travel you had to travel on foot or on a horse and cut down plants in your path. One of their tasks was to find an all-water route to the Pacific Ocean.)
4. *Evaluative* How do you think all the explorers felt as they began their trip? (The explorers might have felt nervous and excited.)



← **Show image 5A-4: Lewis and Clark's projected path**

5. *Literal* Where did Lewis and Clark begin their journey? (Lewis and Clark began their journey at St. Louis on the Missouri River.)

[Please continue to model the *Question? Pair Share* process for students, as necessary, and scaffold students in their use of the process.]

6. *Evaluative When? Pair Share:* Asking questions after a read-aloud is one way to see how much everyone has learned. In a moment you are going to ask your neighbor a question about the read-aloud that starts with the word *when*. For example, you could ask, "When did today's read-aloud take place?" Turn to your neighbor and ask your *when* question. Listen to

your neighbor's response. Then your neighbor will ask a new *when* question, and you will get a chance to respond. I will call on several of you to share your questions with the class.

7. After hearing today's read-aloud and questions and answers, do you have any remaining questions? [If time permits, you may wish to allow for individual, group, or class research of the text and/or other resources to answer these questions.]

### Word Work: Expedition

5 minutes

1. In the read-aloud you heard, "[Lewis and Clark] finally put together a team of trusty men who were daring and brave enough for the *expedition*."
2. Say the word *expedition* with me.
3. An expedition is a kind of journey or trip that has a specific purpose, like exploring. Often an expedition is an adventurous journey.
4. The brothers decided to go on an expedition to climb to the top of the tallest mountain.
5. What kind of expedition would you want to go on? [Ask two or three students. If necessary, guide and/or rephrase students' responses: "I would want to go on an expedition to \_\_\_\_\_ because . . ."]
6. What's the word we've been talking about?

Use a *Drawing* activity for follow-up. Directions: Draw a picture of yourself on an expedition. Include details that describe how you would prepare and where you would go and why. Remember to answer in complete sentences and use the word *expedition* in your response. [Have students share their drawings and writing with a partner or the class.]



### Complete Remainder of the Lesson Later in the Day



# Lewis and Clark: The Journey Begins

6<sub>B</sub>

**Note:** Extensions may have activity options that exceed the time allocated for this part of the lesson. To remain within the time periods allocated for this portion of the lesson, you will need to make conscious choices about which activities to include based on the needs of your students.

## Extensions

20 minutes



### Explorer's Journal #5 (Instructional Master 6B-1)

15 minutes

#### ← Show image 6A-6: Setting out

- Have students describe what is happening in this image. (The Corps of Discovery are beginning their expedition of the west.)
- Tell students to pretend they are a member of the Corps of Discovery and are just beginning their journey. They will write an entry in their “diary.” Remind students that a diary is a book or journal for writing down thoughts and experiences. Point out that the date for this diary entry is May 14, 1804, the day the Corps of Discovery began their expedition.
  - First, students should think about how they would feel if they were about to go on this expedition.
  - Next, they should think about what they hope to see and do.
  - Then, they should write several sentences on the diary page about their feelings and hopes for this expedition.
  - Finally, students should share their writing with their partner or home-language peers.

### Domain-Related Trade Book or Student Choice

20+ minutes

#### Domain-Related Trade Book

- Refer to the list of recommended trade books in the Introduction at the front of this *Supplemental Guide*, and choose one

trade book about Lewis and Clark to read aloud to the class.  
[Suggested trade books are items # 6–9, 13, and 15 on the list.]

- Explain to students that the person who wrote the book is called the author. Tell students the name of the author. Explain to students that the person who makes the pictures for the book is called an illustrator. Tell students the name of the illustrator. Show students where they can find this information on the cover of the book or on the title page.
- As you read, use the same strategies that you have been using when reading the read-aloud selections—pause and ask text-based questions to ensure comprehension; rapidly clarify critical vocabulary within the context of the read-aloud; etc.
- After you finish reading the trade book aloud, lead students in a discussion as to how the story or information in this book relates to the read-alouds in this domain. Discuss whether the trade book was fiction or nonfiction, fantasy or reality, historical or contemporary.
- Provide students with drawing paper, drawing tools and writing tools. Have students draw one detail they remember from the trade book. Students may also draw one new thing that they learned from the trade book that they did not know before. Students should label their pictures and write a sentence to go along with their drawings. Have students share their drawings and writing with their partner or with home-language peers.

### ***Student Choice***

- Tell students that they will vote for one read-aloud they have heard recently that they would like to hear again. On a piece of chart paper, a chalkboard, or a whiteboard, make a bar graph with the six most recent read-aloud titles along one side. Read the titles to students, and if necessary, show key illustrations to remind them about the content of these read-alouds.
- Then have each student write his or her name on a sticky note and come up to the chart paper, a chalkboard, or a whiteboard to cast his or her vote, creating a bar graph of their selections.

- Have students tell you which read-aloud had the most votes on the Student Choice bar graph, and read that read-aloud again. You may also want to choose a read-aloud yourself.
- Reread the text that is selected. Feel free to pause at different places in the read-aloud this time and talk about vocabulary and information that you did not discuss previously during the read-aloud.
- After the read-aloud, ask students if they noticed anything new or different during the second reading that they did not notice during the first reading. Also, ask them to try to express why they like this read-aloud. Remember to repeat and expand upon each response using richer and more complex language, including, if possible, any read-aloud vocabulary.





# Discovery and Danger on the Prairie

# 7

## ✔ **Lesson Objectives**

---

### **Core Content Objectives**

---

Students will:

- ✔ Locate the Mississippi River on a map
- ✔ Locate the Rocky Mountains on a map
- ✔ Identify and locate the Louisiana Territory on a map
- ✔ Explain the significance of the Louisiana Territory and Purchase
- ✔ Explain the reasons that Lewis and Clark went on their expedition
- ✔ Explain that there were many, many Native American tribes living in the Louisiana Territory before the Lewis and Clark expedition
- ✔ Recall basic facts about Lewis and Clark's encounters with Native Americans

### **Language Arts Objectives**

---

The following language arts objectives are addressed in this lesson. Objectives aligning with the Common Core State Standards are noted with the corresponding standard in parentheses. Refer to the Alignment Chart for additional standards addressed in all lessons in this domain.

Students will:

- ✔ Draw and write sentences about something that fascinates them, and supply reasons for why they are fascinated by it (W.1.1)
- ✔ Retell the read-aloud by describing Image Cards with relevant details, expressing ideas and feelings clearly (SL.1.4)
- ✔ Share writing with others

## Core Vocabulary

**fascinated, *adj.*** Very interested in or attracted to something

*Example:* Elias was fascinated by frontier life and borrowed fifteen books from the library about it.

*Variation(s):* none

**guided, *v.*** Led by someone or something

*Example:* The marks on the trees guided the pioneers through the Appalachian Mountains.

*Variation(s):* guide, guides, guiding

**honored, *v.*** Respected and admired

*Example:* The class honored their teacher during Teacher Appreciation Week.

*Variation(s):* honor, honors, honoring

**prairie, *n.*** A large, flat, area of land covered with grass

*Example:* The grass on the prairie waved as the wind blew.

*Variation(s):* prairies

Vocabulary Chart for Discovery and Danger on the Prairie			
Core Vocabulary words are in <b>bold</b> . Multiple Meaning Word Activity word is <u>underlined</u> . Vocabulary Instructional Activity words have an asterisk (*). Suggested words to pre-teach are in <i>italics</i> .			
Type of Words	Tier 3 Domain-Specific Words	Tier 2 General Academic Words	Tier 1 Everyday-Speech Words
<b>Understanding</b>	(pronghorn) antelope expedition keelboat/pirogue <b>prairie</b> <i>Sioux</i>	bravery courage danger discovery <b>guided</b> impressed suddenly tasks	animals friend/friendship gifts horse ocean tunnels
<b>Multiple Meaning</b>	chief	<b>fascinated*</b> <b>honored</b> ordered stretched	
<b>Phrases</b>	Great Plains prairie dog Native Americans Teton Sioux Yankton Sioux		
<b>Cognates</b>	antilope expedición <b>pradera</b> jefe	coraje descubrimiento <b>guiado</b> impresionado <b>fascinado*</b> <b>honrado</b>	animales océano túnel

**Note:** Introducing the Read-Aloud and Extensions may have activity options that exceed the time allocated for that part of the lesson. To remain within the time periods allocated for each portion of the lesson, you will need to make conscious choices about which activities to include based on the needs of your students.

Exercise	Materials	Details
<b>Introducing the Read-Aloud (10 minutes)</b>		
Where Are We?	Frontier Explorers Map; U.S.map	Have students find the landmarks on their own maps.
What Have We Already Learned?	Image Cards 11–13; Tasks Checklist	Use the Tasks Checklist to review the three tasks President Jefferson gave Lewis and Clark.
Vocabulary Preview: Prairie, Sioux	Images of the prairie or Great Plains	
	Image Card 17 (Yankton Sioux) and 18 (Teton Sioux)	
Purpose for Listening		
<b>Presenting the Read-Aloud (15 minutes)</b>		
Discovery and Danger on the Prairie		
<b>Discussing the Read-Aloud (15 minutes)</b>		
Comprehension Questions	Tasks Checklist	Use this to answer Question #5.
Word Work: Fascinated	Image 7A-2; drawing paper, drawing and writing tools	
 <b>Complete Remainder of the Lesson Later in the Day</b>		
<b>Extensions (20 minutes)</b>		
Tracking Lewis and Clark and the Corps of Discovery	Frontier Explorers Map; blue, yellow, and red crayons or markers; U.S. map	
Explorer’s Journal #6	Image Cards 15–18; Instructional Master 7B-1	

### ***Advance Preparation***

For Vocabulary Preview, find images of a prairie or the Great Plains to give students a better understanding of what a prairie is and the animals and plants that are found on a prairie.

Make a copy of Instructional Master 7B-1 for each student. This will be the sixth page of the students' *Explorer's Journal*. They will draw and write about the most interesting thing they have seen or experienced so far in Lewis and Clark's and the Corps of Discovery's expedition.

### ***Notes to Teacher***

You may wish to pause after reading the following sections and briefly review read-aloud content:

After reading the section for Image 7A-3, briefly review what a prairie is and the plants and animals found on a prairie.

After reading the section for Image 7A-5, briefly discuss the group's experiences with the two tribes.

After reading the section for Image 7A-10, have students predict what they think might happen next.



# Discovery and Danger on the Prairie

7  
A

**Note:** Introducing the Read-Aloud may have activity options that exceed the time allocated for this part of the lesson. To remain within the time periods allocated for this portion of the lesson, you will need to make conscious choices about which activities to include based on the needs of your students.

## ***Introducing the Read-Aloud***

**10** minutes

### **Where Are We?**

5 minutes

Help students locate the Atlantic Ocean, the Appalachian Mountains, the Mississippi River, the Rocky Mountains, the Louisiana Purchase, the Missouri River, and the Pacific Ocean on a map.

Explain that today's read-aloud takes place in a part of the United States that we now call the Great Plains. Point out the Great Plains to students. (The Great Plains is made up of Colorado, Kansas, Montana, Nebraska, New Mexico, North Dakota, Oklahoma, South Dakota, Texas, and Wyoming.)

### **What Have We Already Learned?**

5 minutes

Review with students the three tasks Lewis and Clark were asked to accomplish on their expedition. You may wish to use Image Cards 11–13 when you talk about each task.

Tell students that while not a lot of pioneer families who lived in the United States had traveled into the Louisiana Territory, many Native Americans had already been living there for a very long time.

### **Vocabulary Preview**

5 minutes

#### ***Prairie***

1. The setting of today's read-aloud is on a *prairie*.
2. Say the word *prairie* with me three times.

3. [Show a picture of a prairie.] A prairie is a large, flat, area of land that is covered with grass.
4. The rabbit was hidden behind the tall and wild grass of the prairie.
5. [Show additional images of the prairie or the Great Plains.] What do you see in this picture? Describe a prairie to your partner.

### ***Sioux (soo/sooz)***

1. In today's read-aloud, Lewis and Clark and the Corps of Discovery meet two different Native American *Sioux* tribes.
2. Say the name *Sioux* with me three times.
3. Sioux (sooz) are a group of Native American people who are from the plains of the northern United States.  
[Show Image Card 17 (Yankton Sioux).] First, the group will meet the Yankton Sioux (YANGK-tuhn sooz).  
[Show Image Card 18 (Teton Sioux).] Then, the group will meet the Teton Sioux (TEE-ton sooz).  
The Yankton Sioux and the Teton Sioux lived in different parts of the Great Plains.
4. The Sioux had been living on the Great Plains for a very long time.
5. What was one of the tasks that Lewis and Clark had that had to do with the Native Americans? (become friends with the Native Americans)

### **Purpose for Listening**

---

Tell students that in today's read-aloud, Lewis and Clark will have an opportunity to accomplish two of their three tasks. Tell students to listen to find out which two tasks Lewis and Clark will have an opportunity to accomplish and whether or not they will be successful.



## Discovery and Danger on the Prairie

### ← Show image 7A-1: Clark and the Great Plains

- 1 A prairie is also called a grassland. [Talk with students about the grassland habitat they learned about in the *Animals and Habitats* domain.]
- 2 So the prairie looked like an ocean because it went on as far as the eye could see.

On July 19, 1804, William Clark found himself at the edge of an ocean. It was not the Pacific Ocean, the vast sea to the west that Clark and his friends hoped to reach. In fact, it was not an ocean of water at all. It was a large, flat area of land covered in grass called a **prairie**.<sup>1</sup> A prairie goes on as far as the eye can see, just like the ocean.<sup>2</sup>

Clark was out hunting for the expedition and spotted some elk tracks, which he followed up a hill. He later described what he found at the top. “I came suddenly into an open and boundless prairie. I could not see [the edges] in any direction. This . . . was so sudden and entertaining that I forgot the [elk I had been following].” Clark had reached the eastern edge of what today we call “The Great Plains.” Wild grass as high as Clark’s knees stretched out and blew gently in the wind, interrupted every so often by a hill or a grove of trees. That sea of grass stretched all the way to the distant Rocky Mountains, which it would take the Corps of Discovery weeks more to reach.<sup>3</sup>

- 3 [Remind students that the Corps of Discovery was the group of people who were traveling with Lewis and Clark.]



### ← Show image 7A-2: Pronghorn antelope

- 4 or very interested

During those weeks, the explorers saw many plants and animals new to them. Meriwether Lewis was especially **fascinated**<sup>4</sup> by the pronghorn antelope, called pronghorns for short. He tried to get close enough to draw pictures of them, but the pronghorns always ran away. Pronghorns have incredibly sharp eyesight and a strong sense of smell to warn them of approaching danger. When Lewis finally came close to a pronghorn and got a good look at the long, curved horns that give the animal its name, he wrote, “The speed of this animal is equal, if not superior, to that of the finest [racing horse.] [The pronghorn] is my favorite of all the animals we have encountered so far.”



← **Show image 7A-3: Prairie dog**

The explorers were also astonished by the prairie dog, a tiny rodent. These little creatures, related to squirrels, lived together by the thousands in what the men came to call “prairie dog towns.” The prairie dog towns consisted of underground tunnels that sometimes stretched out for miles across the flat plains. “We have to catch one of these to send back to President Jefferson,” William Clark declared. But catching a prairie dog was not so easy. One prairie dog, standing guard above its hole in the ground, saw the men coming and chirped a high pitched warning. Instantly, all the creatures dived down into the ground. The men dug down after them but found that the tunnels went down more than six feet below the surface, spreading out in all directions with emergency exits to escape their many predators—hawks, coyotes, and snakes—all of whom considered prairie dogs to be delicious snacks. Clark wrote down their findings about the prairie dog and pronghorn antelope in his journal.



← **Show image 7A-4: With the Yankton Sioux**

Still following the Missouri River across the prairie, the expedition moved on. Soon they began to meet new tribes of Native Americans. Most were friendly and welcoming, especially one tribe called the Yankton Sioux.

5 or led

A few of the Yanktons **guided**<sup>5</sup> the travelers for a few days, but then said, “You are coming to the land of the Teton Sioux. We will not be able to guide you any longer.”



← **Show image 7A-5: Teton Sioux**

Lewis and Clark had already heard about the Teton Sioux. President Jefferson wanted them to become friends with the Teton Sioux. However, the Teton Sioux were not interested in trade with the settlers and did not want to allow Lewis and Clark on their land.



← **Show image 7A-6: Stealing a horse**

One September afternoon, John Colter, one of the expedition’s best hunters, was following the tracks of an animal. Colter



6 *Dismounted* means he got off his horse.

dismounted from his horse to look more closely.<sup>6</sup> Some Teton Sioux, hiding among the nearby trees on their own horses, shouted and rushed forward, riding off with Colter's horse. Colter walked back to the river and reported to Lewis and Clark what had happened. Minutes later, five Teton Sioux appeared on the shore calling out to talk to Lewis and Clark. Captain Clark answered, "We will not speak with you until our horse is returned."



← **Show image 7A-7: Confrontation**

Minutes later, more than two hundred Teton warriors, all armed with bows and arrows, rode out from the trees and spread out along the riverbank.<sup>7</sup>

7 Warriors are people who fight in a battle. The Teton Sioux are prepared to fight to protect their land.

Captain Lewis remembered that President Jefferson wanted them to be friends with the Teton Sioux. He quietly ordered, "Stop the boats and hold them steady here in the middle of the river." Clark, smiling, called, "We come as friends from our great chief." The chief that Clark was talking about was President Jefferson. "We invite your chiefs to come and see our great boat."



← **Show image 7A-8: Giving gifts**

Clark ordered a few sailors to row him to shore in a pirogue, and after greeting the three main chiefs, Clark brought two of them aboard the keelboat. There he and Lewis were friendly to the Teton Sioux and gave them gifts. Then Clark and the oarsmen took the chiefs back to the shore.<sup>8</sup>

8 [Point to the oarsman in the picture.]



← **Show image 7A-9: Taking the leaders back to shore**<sup>9</sup>

Meanwhile, Captain Lewis stood ready on the keelboat's bow, and his soldiers kept rifles in their hands or immediately by their sides in case of trouble. Everything seemed to be going well until suddenly one chief shouted, "Your gifts are not good enough. You may not return to your big boat until you give us better gifts." Sioux warriors grabbed the pirogue's rope and held it securely.

9 [Point to the boat in the picture.]



10 *Honored* means the Teton Sioux admired and respected people who acted bravely.

← **Show image 7A-10: Clark's bluff**

Clark knew that the Teton Sioux **honored** courage.<sup>10</sup> If he showed any sign of weakness at this moment, the Tetons might attack. Even if there were no fight, any chance of a strong friendship with the Tetons could disappear. Clark whipped his sword out, and holding it high, firmly demanded, "Release our boat *at once!*"

Back on the keelboat, Lewis ordered his men, "Prepare arms! Only on my order may you fire, and *not a second* before." Instantly, the soldiers raised their rifles. In answer, the Tetons raised their bows and set arrows, ready to shoot at the Corps of Discovery.

No one moved. The silence stretched out for a long, tense moment. Then a Sioux chief told the warriors holding the rope, "Let go." They obeyed. Clark told his oarsmen, "Return to the keelboat."

One of his men asked quietly, "Without you, sir?"

"I gave you an order," Clark said in a voice that sounded much calmer than he actually felt.



← **Show image 7A-11: Clark surrounded**

As the pirogue pushed off from the riverbank, Teton warriors surrounded Clark. Lewis could see only his friend's hat over the shoulders of the Sioux. Lewis gave orders, and as the pirogue reached the keelboat, a number of armed soldiers got into the pirogue and started back for Clark. But then, suddenly, the Tetons moved away from Clark.



← **Show image 7A-12: Truce at last**

Clark's bravery had impressed the Tetons. The Tetons thought that Clark was brave because he stood up to them. They smiled in friendship and invited the members of the expedition to their village. The explorers accepted the invitation. The Corps of Discovery had survived a dangerous situation. What they did not know was that even greater dangers, and even greater victories, still lay ahead.

### Comprehension Questions

10 minutes

1. *Literal* What is the area called where today's read-aloud took place? (Today's read-aloud took place in an area called the Great Plains.)
2. *Literal* What animals did Lewis and Clark discover? (Lewis and Clark discovered prairie dogs and pronghorn antelopes.)
3. *Literal* Before Lewis and Clark's explorations, pioneer families living in the United States had not explored or settled the Louisiana Territory. Who had been living on that land for thousands of years? (Many Native American tribes had lived there for a long time.)
4. *Evaluative* In the read-aloud, Lewis and Clark met two different Native American tribes, the Yankton Sioux and the Teton Sioux. How were their meetings with the two tribes different? How were they the same? [You may wish to use Image Cards 17 (Yankton Sioux) and 18 (Teton Sioux) to help the students remember.] (The Yankton Sioux were friendly, but the Teton Sioux were not friendly. Both became friends with Lewis and Clark.)
5. *Literal* Which two of President Jefferson's tasks did Lewis and Clark accomplish in the read-aloud? (Lewis and Clark accomplished two tasks: making friendships with Native Americans and discovering new animals and plants.)

[Please continue to model the *Think Pair Share* process for students, as necessary, and scaffold students in their use of the process.]

I am going to ask a question. I will give you a minute to think about the question, and then I will ask you to turn to your neighbor and discuss the question. Finally, I will call on several of you to share what you discussed with your partner.

6. *Evaluative Think Pair Share:* The title of this read-aloud is "Discovery and Danger on the Prairie." What do you think was discovered and what was dangerous in this read-aloud? (Answers may vary.)

7. After hearing today’s read-aloud and questions and answers, do you have any remaining questions? [If time permits, you may wish to allow for individual, group, or class research of the text and/or other resources to answer these questions.]



### Word Work: Fascinated

5 minutes

← Show image 7A-2: Pronghorn antelope

1. In the read-aloud you heard, “Meriwether Lewis was especially *fascinated* by the pronghorn antelope, called pronghorns for short.”
2. Say the word *fascinated* with me.
3. *Fascinated* means very interested in or attracted to something.
4. The fascinated explorers stared as the thousands of prairie dogs scurried across the grass and into their tunnels. Elias is fascinated about frontier life and borrowed fifteen books from the library about it.
5. Can you think of a time you have felt fascinated by something?  
[Ask two or three students. If necessary, guide and/or rephrase students’ responses: “I was fascinated when . . .”]
6. What’s the word we’ve been talking about?

Use a *Drawing* activity for follow-up. Directions: Draw a picture of something that fascinates you. Then write a sentence explaining why you are fascinated by it.

[Have students share their drawings and writing with a partner or the class.]



### Complete Remainder of the Lesson Later in the Day



# Discovery and Danger on the Prairie

7  
B

**Note:** Extensions may have activity options that exceed the time allocated for this part of the lesson. To remain within the time periods allocated for this portion of the lesson, you will need to make conscious choices about which activities to include based on the needs of your students.

## ***Extensions***

**20** minutes

### **Tracking Lewis and Clark and the Corps of Discovery**

**10** minutes

- Review the areas students have colored in—the area of the United States at the time of the read-aloud (in orange), the Appalachian Mountains, the Rocky Mountains, and the Mississippi River.
- Explain to students that over the next few days, they will track Lewis and Clark’s progress toward the Pacific Ocean. Have students identify the Pacific Ocean on their maps. Ask: “What was one of Lewis and Clark’s tasks that had to do with the Pacific Ocean?” (find an all-water route to the Pacific Ocean)
- Remind students that Lewis and Clark started their journey in the town of St. Louis. Have students color yellow the dot on their maps that represents St. Louis.
- Point out that it is at St. Louis where the Mississippi River and Missouri River meet. Have students trace the Missouri River in blue. Tell students that the Missouri River flows east and south (into the Mississippi River). Have students trace the flow of the Missouri River.  
Ask: “Which direction does the Missouri River flow?” (east and south)
- Ask: “In which part of the United States did today’s read-aloud take place?” [Hint: It is a place with a lot of grass.] (the Great Plains)

- Point out the Great Plains states: Montana, North Dakota, South Dakota, Wyoming, Nebraska, Colorado, Kansas, New Mexico, and Texas. Ask: “Is the Great Plains a large area?”
- Point out that the Missouri River runs through the Great Plains states. Tell students that Lewis and Clark and the Corps of Discovery followed the Missouri River across the prairie. Have students draw red X’s along the Missouri River up to the middle of South Dakota and stop at the first dot. Remind students that the Teton Sioux lived in that area at the time of today’s read-aloud.

### **Explorer’s Journal #6 (Instructional Master 7B-1)**

**15 minutes**

- Use Image Cards 15–18 and have students tell about what happened when Lewis and Clark and the Corps of Discovery encountered the animals or people on the Image Cards. Be sure students use words like *first*, *next*, *then*, and *last* when retelling the story.
- Tell students to pretend they are a member of the Corps of Discovery and are journeying through the prairie. They will write an entry in their “diary” about the most interesting thing they have seen or experienced so far during this expedition.
  - First, students should think about the animals and people they have encountered so far on this expedition.
  - Next, they should decide what is the most interesting thing they have seen or experienced so far during this expedition.
  - Then, they should draw a picture and write several sentences in their diary about it.
  - Finally, students should share their drawings and writing with their partner or home-language peers.

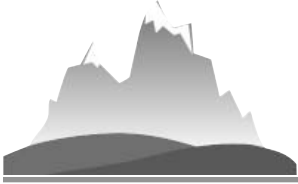

## ☑ **Lesson Objectives**

---

### **Core Content Objectives**

---

Students will:

- ✓ Locate the Mississippi River on a map
- ✓ Locate the Rocky Mountains on a map
- ✓ Identify and locate the Louisiana Territory on a map
- ✓ Explain the significance of the Louisiana Territory and Purchase
- ✓ Explain the reasons that Lewis and Clark went on their expedition
- ✓ Explain that there were many, many Native American tribes already living in the Louisiana territory before the Lewis and Clark expedition
- ✓ Recall basic facts about Lewis and Clark’s encounters with Native Americans
- ✓ Explain why and how Sacagawea helped Lewis and Clark

### **Language Arts Objectives**

---

The following language arts objectives are addressed in this lesson. Objectives aligning with the Common Core State Standards are noted with the corresponding standard in parentheses. Refer to the Alignment Chart for additional standards addressed in all lessons in this domain.

Students will:

- ✓ Write sentences about Sacagawea’s role on the expedition, respond to questions and suggestions from peers, and add details to strengthen writing as needed (W.1.5)
- ✓ Ask and answer *where* questions orally, requiring literal recall and understanding of the details and facts from “Sacagawea” (SL.1.2)

- ✓ Add drawings to a classmate’s written description of Sacagawea’s role on the expedition to clarify ideas, thoughts, and feelings (SL.1.5)
- ✓ Share writing with others

### Core Vocabulary

---

**permanent, adj.** Lasting a long time; unchanging

*Example:* The paint left a permanent stain on the carpet.

*Variation(s):* none

**plunged, v.** Fell or dropped quickly

*Example:* The frog plunged into the lake.

*Variation(s):* plunge, plunges, plunging

**protection, n.** Something that keeps you safe

*Example:* During the summer, we use sunscreen for protection against the sun’s rays.

*Variation(s):* none

**skilled, adj.** Trained to do something or being good at something

*Example:* Her dream was to become a skilled ice skater.

*Variation(s):* none

**translate, v.** To change words from one language into another

*Example:* The boy knew two languages and was able to translate from one to the other.

*Variation(s):* translates, translated, translating



### Vocabulary Chart for Sacagawea

Core Vocabulary words are in **bold**.  
 Multiple Meaning Word Activity word is underlined.  
 Vocabulary Instructional Activity words have an asterisk (\*).  
 Suggested words to pre-teach are in *italics*.

Type of Words	Tier 3 Domain-Specific Words	Tier 2 General Academic Words	Tier 1 Everyday-Speech Words
<b>Understanding</b>	bison blacksmiths expedition Hidatsa maggie Mandan plains <i>Sacagawea</i> Shoshone tribe	decisions information journal <b>permanent</b> <b>plunged</b> <b>protection*</b> <b>skilled</b> task <i>translate</i> welcomed	animals boat doctors east/west farmed food river winter
<b>Multiple Meaning</b>	hunting lodge	freezing* froze sample spent split	drawing party plant <u>trunk</u>
<b>Phrases</b>	earth lodges "Fort Mandan" prairie dog Rocky Mountains Toussaint Charbonneau		
<b>Cognates</b>	bisonte expedición tribu	decisiones información <b>permanente</b> <b>protección*</b>	animales bote doctores este/oeste planta

**Note:** Introducing the Read-Aloud and Extensions may have activity options that exceed the time allocated for that part of the lesson. To remain within the time periods allocated for each portion of the lesson, you will need to make conscious choices about which activities to include based on the needs of your students.

Exercise	Materials	Details
<b>Introducing the Read-Aloud (10 minutes)</b>		
<b>Where Are We?</b>	Frontier Explorers Map; U.S. map	Have students find the landmarks on their own maps.
<b>What Have We Already Learned?</b>	Image Cards 11–13; Tasks Checklist	Use the Tasks Checklist to review the three tasks President Jefferson had given Lewis and Clark. Ask students which two tasks they have accomplished. (discovering new plants and animals; making friendships with the Native Americans)
	Image 8A-2	Make sure that students understand that they will meet more Native American tribes in today’s read-aloud. Show them the Flip Book image. Have students point out Lewis and Clark and their group on the river, the Mandans (MAN-dans) on the shore, and the village.
<b>Essential Background Information or Terms</b>	Image 6A-4	Show image with George Drouillard (dru-YAR) to remind students that he had language skills—he could communicate in French, some Native American languages, and sign language used by Native Americans.
	chart paper, blackboard, or whiteboard; drawing tools	You may wish to ask students about the languages other than English that they know. Record their responses on a chart titled “The Languages We Know.”
<b>Vocabulary Preview: Sacagawea, Translate</b>	Image 8A-6; additional images of Sacagawea; Instructional Master 3A-1 (Idea Web)	Make an Idea Web for Sacagawea. Continue to add to it throughout the rest of this domain.
	“The Languages We Know” chart (optional)	

Exercise	Materials	Details
Purpose for Listening		
<b>Presenting the Read-Aloud (15 minutes)</b>		
Sacagawea	Image Card 16 (Prairie Dog); image of a black-billed magpie; images of bison; videos of prairie dogs, magpies, and bison	At a separate time, you may wish to show short video clips of prairie dogs, magpies, and bison.
<b>Discussing the Read-Aloud (15 minutes)</b>		
Comprehension Questions	Tasks Checklist	Use this to answer Question #8.
Word Work: Protection		
 <b>Complete Remainder of the Lesson Later in the Day</b>		
<b>Extensions (20 minutes)</b>		
Multiple Meaning Word Activity: Trunk	Poster 4M (Trunk)	
Syntactic Awareness Activity: Sentence Types	Punctuation Marks; Images 8A-4 and 8A-7	
Vocabulary Instructional Activity: Freezing	Image 8A-4; chart paper, index cards, tape, marker	
Tracking Lewis and Clark and the Corps of Discovery	Frontier Explorers Map; red crayon or marker; U.S. map	
Interactive Illustrations	Instructional Master 8B-1; writing and drawing tools	

### **Advance Preparation**

For *Vocabulary Preview*, find images of Sacagawea to show students.

Make a large Idea Web for Sacagawea. Record how Sacagawea was helpful to the expedition.

 **Above and Beyond:** Make a copy of Instructional Master 3A-1 for students who are ready to complete this web on their own.

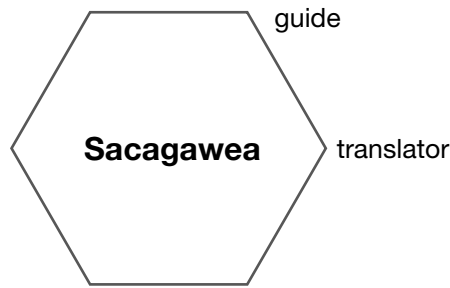

For the *Vocabulary Instructional Activity*, create a Horizontal Word Wall by drawing a horizontal line from left to right on a large piece of chart paper. Write each of the following words on an individual index card: *freezing, frigid, icy, frosty, chilly, cold, cool, warm, hot, balmy, burning, and scorching*.

For *Presenting the Read-Aloud*, find images of black-billed magpies and bison to show students. Find age-appropriate short videos of prairie dogs, magpies, and bison for students to view at a later time.

Make a copy of Instructional Master 8B-1 for each student. This will be their Interactive Illustrations activity page.

### ***Notes to Teacher***

You may wish to pause and do the following during the read-aloud:

After reading the section for Image 8A-5, briefly review Lewis and Clark's encounter and relationship with the Mandans (MAN-dans).

Before reading the last paragraph for Image 8A-6, have students predict what Lewis and Clark will decide. Take a quick class tally of whether they will invite Charbonneau (shar-bahn-O) and Sacagawea (sa-KA-ja-WE-uh) to join them on their expedition.



**Note:** Introducing the Read-Aloud may have activity options that exceed the time allocated for this part of the lesson. To remain within the time periods allocated for this portion of the lesson, you will need to make conscious choices about which activities to include based on the needs of your students.

## ***Introducing the Read-Aloud***

**10** minutes

### **Where Are We?**

5 minutes

Help students locate the Atlantic Ocean, the Appalachian Mountains, the Mississippi River, the Rocky Mountains, the Louisiana Purchase, the Missouri River, and the Pacific Ocean on a map. Explain that today's read-aloud takes place near the Rocky Mountains.

### **What Have We Already Learned?**

5 minutes

Review with students the three tasks President Jefferson asked Lewis and Clark to accomplish on their expedition. You may wish to use Image Cards 11–13 when you talk about each task.

Remind students that while not a lot of pioneer families who lived in the United States at that time had gone into the Louisiana Territory, Native Americans had lived there for a very long time. Talk with students about the Corps of Discovery's encounter with the Teton Sioux and the Yankton Sioux. Explain to students that today they will learn about two more Native American tribes, the Mandan (*MAN-dan*) and Hidatsa (*hee-DAHT-sah*).



### **Essential Background Information or Terms**

10 minutes

#### ← **Show image 6A-4: George Drouillard**

Remind students that Lewis and Clark needed people in the Corps of Discovery who could speak languages other than English. Ask students why they think Lewis and Clark needed people who could speak other languages.

Explain to students that Lewis and Clark needed to be able to communicate with Native American tribes, each of which spoke their own language. For example, Lewis understood and spoke only English. If he wanted to talk to someone who spoke only French, not English, he needed the help of someone who understood and spoke both French and English, like George Drouillard. Lewis might first say something in English, and then George would say what Lewis had said in French so the other person could understand.

Explain to students that someone like George Drouillard is called a *translator*. A translator is someone who is able to say the same thing in more than one language; he can listen to what someone says in one language and then repeat it in a completely different language.

## Vocabulary Preview

5 minutes



### *Sacagawea (sa-KA-ja-WE-uh)*

#### ← Show image 8A-6: Charbonneau and Sacagawea

1. The title of today's read-aloud is called "Sacagawea."
2. Say the name *Sacagawea* with me three times.
3. Sacagawea was a Native American woman from the Shoshone (shoh-SHOH-nee) tribe.
4. In this image Sacagawea and her husband, Toussaint Charbonneau (tu-SAHN shar-bahn-O), are about to meet Lewis and Clark.
5. [Show additional images of Sacagawea.] You will hear about Sacagawea in several read-alouds. Tell your partner why you think Sacagawea was important to Lewis and Clark.

### *Translate*

1. Lewis understood and spoke only English, so he needed someone to help him *translate* other languages into English.
2. Say the word *translate* with me three times.
3. *To translate* means to change words from one language into

another language.

4. George Drouillard (dru-YAR) helped translate French into English for Lewis.
5. [If there are students who can speak a language other than English, invite them to translate your sentences.] Can you help me translate:  
*Hello! How do you do?*  
*Will you be my friend?*  
*Let's play!*  
*Let's eat!*

### **Purpose for Listening**

---

Tell students that today they will hear about where Lewis and Clark spent the winter of their expedition and the people they met while they were there. Tell students to listen to find out where Lewis and Clark spent the winter and who they decided to hire as a guide and translator.



## Sacagawea

### ← Show image 8A-1: Approaching winter

As autumn approached, Lewis and Clark were in a hurry. They knew the Rocky Mountains lay ahead, and they hoped to spend the winter there among the Mandan (*MAN*-dan) and Hidatsa (*hee-DAHT*-sah).<sup>1</sup> However, it was already so cold that the river was freezing into ice, and when the river froze, it was impossible to travel up the river in their boats.

1 The Mandan and Hidatsa are two Native American tribes who had been friendly to Lewis and Clark.



### ← Show image 8A-2: Mandan village

Where the Knife River flows into the Missouri, Lewis and Clark found five villages of Hidatsa and Mandan Native Americans. Like other Native Americans living on the plains, these people hunted bison—also known as buffalo—from horseback. They also lived in **permanent** earth lodges and farmed the land around their homes.<sup>2</sup> Four or five families shared each lodge, and even the horses spent bad weather days inside, in a roped-off space just inside the entrance.

2 This means they had shelters that they did not move, unlike nomads who moved their shelters with them.

The Mandans especially welcomed the travelers from the east, because they were used to visitors. Other Native American tribes and trappers came to the Mandan area to share news and to buy and sell furs from beavers, bear, elk, or bison.



### ← Show image 8A-3: Fort walls

Across the river from one of the Mandan villages, the explorers built a wooden house and surrounded it with log walls eighteen feet high for **protection**.<sup>3</sup> The men of the Corps of Discovery called their winter home “Fort Mandan,” named after the Mandan Native Americans.

3 They made the high log walls to keep them safe.





← **Show image 8A-4: Wintertime troubles**

They dragged the pirogues onto the riverbank, but before they could move the keelboat, the river froze around it. It took three weeks to chop the keelboat out of the ice.<sup>4</sup>

4 When the river froze, it froze around the boat, and the keelboat became stuck in the ice.

They had other worries, too. Lewis told Clark, “We are eating so much food that we will run out before the winter is over, and in this terrible weather, it is getting harder to hunt.”



← **Show image 8A-5: Mandan interactions**

Thankfully, the Mandans appeared one day to tell them, “We have found a herd of bison nearby. Come hunting with us. We have brought horses for you to ride.” The result was more food and warm blankets made from their hides. As the winter nights grew long and temperatures **plunged**<sup>5</sup> to thirty, even forty, degrees below zero, the explorers also traded with the Mandan for food. In return for the food the Mandan gave them, Lewis and Clark acted as doctors for members of the tribes who were sick or injured, and several of the explorers who were **skilled**<sup>6</sup> as blacksmiths made iron tools, axes, and arrowheads for the Mandans.<sup>7</sup>

5 or fell quickly

6 or talented

7 Do you think Lewis and Clark’s Corps of Discovery and the Native Americans treated one another fairly?

8 Why do you think Lewis and Clark kept information in a journal?

The party spent many cold nights asking the Hidatsas and Mandans about the country that lay ahead. Lewis and Clark kept all the information they learned in a journal.<sup>8</sup>



← **Show image 8A-6: Charbonneau and Sacagawea**

Then one day, a French-Canadian trader appeared at the gates of Fort Mandan. He announced, “I am Toussaint Charbonneau (tu-SAHN shar-bahn-o). I heard about you from the Hidatsas. I am an excellent cook, and I speak English, French, and several Native American languages. I could cook for you and **translate** what is said in other languages into English.”<sup>9</sup>

9 Lewis and Clark couldn’t speak any of the Native American languages, so they needed people who could talk to them and to the Native Americans they would meet. Also, one of their three tasks was to befriend the Native Americans.

Charbonneau had not come alone. With him was his very pregnant wife, a young Native American woman named Sacagawea (sa-KA-ja-WE-uh). Sacagawea was a member of the Shoshone (shoh-SHOH-nee) tribe who lived farther along

the Missouri River. The Shoshone were the next tribe that Lewis and Clark expected to meet. Lewis and Clark discussed Charbonneau's offer. "Sacagawea could be helpful when we reach the lands of the Shoshone. She could show the Shoshone that we come as friends, and she knows a lot about the countryside there."<sup>10</sup> As for Charbonneau, if he is the cook he claims to be, he will be a welcome addition to our party."

10 Lewis and Clark thought that Sacagawea could be a guide and a translator for the expedition.



Lewis told Charbonneau, "We want you and your wife to join us, and of course we will pay you for your work."

← **Show image 8A-7: Charbonneau, Clark, Sacagawea with her son**

This turned out to be one of the best decisions the co-captains ever made, and while they had agreed to hire two new members of the expedition, they soon had three. One cold night, Sacagawea gave birth to a little boy. Charbonneau, the new father, looked proudly at his newborn son and said, "We shall call you Jean Baptiste (zhaun bap TEEST) Charbonneau." William Clark laughed. "That's an awfully big name for such a little fellow to carry. I'll call him 'Pompey.'" Pompey proved to be a good little traveler, too.<sup>11</sup>

11 Sacagawea's baby was nicknamed Pomp or Pompey.

12 Remember, this was one of their three tasks requested by President Jefferson.

Lewis and Clark organized their notes and drawings and labeled samples of plants and animals they had gathered.<sup>12</sup> When spring came, Clark announced, "We have decided to split the party into two groups. We will send some of you back east to take President Jefferson the things we have collected and written. The rest of us will continue west." Remember, there were no telephones and no e-mail yet, and there was no way to send mail in the Louisiana Territory. Lewis and Clark sent some of the Corps of Discovery to tell Jefferson of their progress and what they had found so far.



← **Show image 8A-8: Parting ways**

On April 7, 1805, some of the party returned back east as planned. They carried with them four boxes and a trunk filled with plant and rock samples, as well as the captains' journals and drawings.<sup>13</sup> They also took with them some living animals, such as a magpie and a prairie dog.<sup>14</sup> Lewis told Clark, "I wish

13 Here, the word *trunk* means a large, strong box used for holding things. The word *trunk* also means an elephant's nose.

14 A magpie is a black and white bird that makes a lot of noise.

15 What was the last task they still had to accomplish?

I could see President Jefferson’s face when that magpie starts chattering away. The president will be mighty pleased; and he will be delighted with all the information in our journals and drawings.”

Clark replied, “He will be even happier when you and I report to him in person that we have reached the Pacific.”<sup>15</sup> Then the two men started westward once more with the remaining men, one woman, Sacagawea, and a baby.

## Discussing the Read-Aloud

15 minutes

### Comprehension Questions

10 minutes

1. *Literal* Who did Lewis and Clark spend the winter with? (Lewis and Clark spent the winter with Native Americans, specifically the Mandan and Hidatsa.)



← Show image 8A-2: Mandan village

2. *Literal* How did the Mandan tribe get food and where did they live? (The Mandan tribe hunted buffalo, farmed, and lived in permanent earth lodges.)
3. *Inferential* When the river started to freeze, why did Lewis and Clark have trouble moving their boats through the water? (They couldn’t travel by boat through the ice.)
4. *Inferential* What kind of relationship did Lewis and Clark have with the Native Americans you learned about today? (Lewis and Clark had a friendly and helpful relationship with the Native Americans we learned about today.) How do you know? (Lewis and Clark and the Mandan helped each other. Lewis and Clark helped Mandan who were sick. The Mandan helped the Corps find food. The Corps members made tools for the Mandan.)
5. *Literal* Who was Sacagawea? (Sacagawea was the Native American woman that Lewis and Clark hired to help them on their expedition.) How did Lewis and Clark think that Sacagawea could be helpful? (She could be a guide and a translator.)

6. *Literal* Why did Lewis and Clark decide to split the expedition into two groups? (Lewis and Clark decided to split the expedition so that one group could travel back to President Jefferson and update him with their findings, while the other group could continue on the journey west.)
7. *Inferential* What did Lewis and Clark have the men take back to Jefferson? (Lewis and Clark had the men take plants, rocks, animals, journals, and drawings back to Jefferson.) Why did Lewis and Clark keep information in journals? (They kept information in a journal to report back to President Jefferson.)
8. *Inferential* Which two of President Jefferson’s three tasks did Lewis and Clark accomplish in the read-aloud today? (Lewis and Clark accomplished two tasks: making friends with Native Americans and collecting samples of different plants and animals.) Which task have they not yet completed? (Lewis and Clark have not yet found a water route all the way to the Pacific Ocean.)

[Please continue to model the *Question? Pair Share* process for students, as necessary, and scaffold students in their use of the process.]

9. *Evaluative Where? Pair Share:* Asking questions after a read-aloud is one way to see how much everyone has learned. Think of a question you can ask your neighbor about the read-aloud that starts with the word *where*. For example, you could ask, “Where does today’s read-aloud take place?” Turn to your neighbor and ask your *where* question. Listen to your neighbor’s response. Then your neighbor will ask a new *where* question, and you will get a chance to respond. I will call on several of you to share your questions with the class.
10. After hearing today’s read-aloud and questions and answers, do you have any remaining questions? [If time permits, you may wish to allow for individual, group, or class research of the text and/or other resources to answer these questions.]

## Word Work: Protection

5 minutes

1. In the read-aloud you heard, “Across the river from one of the Mandan villages, the explorers built a wooden house and surrounded it with log walls eighteen feet high for *protection*.”
2. Say the word *protection* with me.
3. When something is called protection, that means it helps keep someone or something safe from danger and harm.
4. Livie wore sunscreen as protection so that she wouldn’t get sunburned.
5. What kinds of things do you use as protection when you go outside in the sun? [Ask two or three students. If necessary, guide and/or rephrase students’ responses: “I use \_\_\_\_\_ as protection from the sun.”]
6. What’s the word we’ve been talking about?

Use a *Making Choices* activity for follow-up. Directions: I am going to say a list of items. If the item is something you would use as protection from cold weather, say, “I would use that as protection.” If the item is not something you would use as protection from cold weather, say, “I would not use that as protection.” Remember to answer in complete sentences.

1. coat (I would use that as protection.)
2. bathing suit (I would not use that as protection.)
3. hat (I would use that as protection.)
4. gloves (I would use that as protection.)
5. a pair of shorts (I would not use that as protection.)
6. boots (I would use that as protection.)



**Complete Remainder of the Lesson Later in the Day**

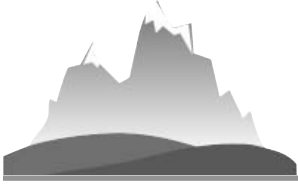

**Note:** Extensions may have activity options that exceed the time allocated for this part of the lesson. To remain within the time periods allocated for this portion of the lesson, you will need to make conscious choices about which activities to include based on the needs of your students.

## Extensions

**20** minutes

### ↔ Multiple Meaning Word Activity

5 minutes

#### *Definition Detective: Trunk*

**Note:** You may choose to have students hold up one, two, or three fingers to indicate which image shows the meaning being described, or have a student walk up to the poster and point to the image being described.

1. In the read-aloud you heard, “Some of the [group] returned back east. They carried with them four boxes and a *trunk* filled with plant and rock samples.”
2. With your partner, think of as many meanings or ways as you can to use the word *trunk*.
3. [Show Poster 4M (Trunk).] In the read-aloud, a trunk is a large, strong box. Which picture shows this type of trunk?
4. A trunk can also be the back part of a car, used for carrying and storing things. Which picture shows this type of trunk?
5. A trunk is also the nose of an elephant. Which picture shows this type of trunk?
6. Did you or your partner think of any of these definitions?
7. With your partner, make up a sentence for each meaning of *trunk*. I will call on some of you to share your sentences. [Call on a few partner pairs to share one or all of their sentences. Have them point to the part of the poster that relates to their use of *trunk*.]

## ↔ Syntactic Awareness Activity

5 minutes

### *Sentence Types*

**Note:** The purpose of these syntactic activities is to help students understand the direct connection between grammatical structures and the meaning of text. These syntactic activities should be used in conjunction with the complex text presented in the read-alouds. There may be variations in the sentences created by your class. Allow for these variations, and restate students' sentences so that they are grammatical. If necessary, have students repeat the sentence after you.

Please change the inflection of your voice to match the punctuation of the sentences you read aloud. Have students hold up the end punctuation for the sentences.



#### ← Show image 8A-4: Wintertime troubles

1. What are the three types of sentences we use? Hold up the punctuation we use for each type. (sentences that give information/period; sentences that ask questions/question mark; sentences that exclaim something/exclamation point)
2. I am going to say several sentences about this image. Repeat the sentence after me, and hold up the correct punctuation mark to show what type of sentence it is.
  - It is freezing out here! (exclamation point)
  - The river freezes in the winter. (period)
  - The keelboat is frozen on the river? (question mark)

Now you try! Say a sentence about this image to your partner. Then your partner should hold up the hold up the correct punctuation mark to show what type of sentence it is. Then, switch roles. I will call on a few of you to share your sentences with the class.



#### ← Show image 8A-7: Charbonneau, Clark, Sacagawea with her son

3. I am going to say several sentences about this image. Repeat the sentence after me, and hold up the correct punctuation mark to show what type of sentence it is.

- Did Sacagawea have her baby? (question mark)
- The baby's nickname is Pompey. (period)
- What a cute little boy! (exclamation point)

Now you try! Say a sentence about this image to your partner. Then your partner should hold up the hold up the correct punctuation mark to show what type of sentence it is. Then, switch roles. I will call on a few of you to share your sentences with the class.

## ↔ Vocabulary Instructional Activity

5 minutes



### Horizontal Word Wall: Freezing

#### ← Show image 8A-4: Wintertime troubles

1. In today's read-aloud you heard that the weather was *freezing* during the winter.
2. *Freezing* means very, very cold.
3. Let's create a Horizontal Word Wall that describes temperature. [Show students the chart paper, and point out the horizontal line.]
4. [Hold up the card for the word *cold*, and read the word aloud.] *Cold* means that the temperature is low. [Tape the card for *cold* towards the left-hand side of the line.]
5. [Hold up the card for the word *hot*, and read the word aloud.] *Hot* means that the temperature is high. [Tape the card for *hot* towards the right-hand side of the line.]
6. [Hold up the card for the word *freezing*, and read the word aloud.] Should the word *freezing* be placed closer to the word *hot* or the word *cold*? [Tape the card near the word *cold* but further left.]
7. [Repeat this process with the remaining cards so that the end result is a horizontal word wall that shows: *freezing, frigid, icy, frosty, chilly, cold, cool, warm, hot, balmy, burning, and scorching*. When all the cards have been attached to the word wall, read over the words with students.]



[Display the Horizontal Word Wall throughout the domain, and encourage students to add additional words to the wall.]

### **Tracking Lewis and Clark and the Corps of Discovery** 10 minutes

---

- Review the areas students have colored in—the area of the United States at the time of the read-aloud (in orange), the Appalachian Mountains, the Rocky Mountains, the Mississippi River, and the Missouri River.
- Remind students that Lewis and Clark started their journey in the town of St. Louis. Have students put their finger on the dot that represents St. Louis on their maps.
- Then, have students follow the red X's along the Missouri River and stop at the first dot. Remind students that in the previous read-aloud, Lewis and Clark met the Yankton Sioux (YANGK-tuhn sooz) and the Teton Sioux (TEE-ton sooz). Ask: “Where did these two tribes of Sioux live?” (on the prairie, the Great Plains)
- Tell students that Lewis and Clark and the Corps of Discovery continued along the Missouri River towards the Rocky Mountains. Have students draw red X's along the Missouri River up to the middle of North Dakota and stop at the second dot. Remind students that this was where the Hidatsa and Mandan lived at the time of today's read-aloud.
- Have students describe the route this expedition has taken so far, using cardinal directions when possible. (headed west and north)
- Point out that they started in St. Louis and traveled along the Missouri River. Ask: “Have Lewis and Clark traveled a long distance? How close are they to the Pacific Ocean? What might be a barrier to them reaching the Pacific Ocean?” Be sure that students use their maps to answer the questions.

### **Interactive Illustrations (Instructional Master 8B-1)** 20 minutes

---

- Explain to students that they will all get to be authors and illustrators in this activity.
- Give every student an activity page. Point out the part where the author will write and the part where the illustrator will draw.

- Have each student write a sentence about the read-aloud on the writing lines.
- Next have each student read their sentence to their partner. Allow partners to ask one another questions about their sentences so they are clear about what their partner wrote. Students may make edits if necessary.
- Then partners should exchange activity pages. Students should draw a picture that goes with their partner's sentence. When they have finished their drawings, they should hand the activity page back to the original author.
- Encourage the author to add descriptive words to his or her original sentence using carets, and hand the papers back to the illustrators to draw more details into the illustration.
- Have students discuss how their partners' illustrations differed from the pictures they had imagined in their heads when they wrote their sentences. As students discuss the illustrations, remember to repeat and expand upon each response using richer and more complex language, including, if possible, any read-aloud vocabulary.



# Red Cedars and Grizzly Bears

9

## ✓ **Lesson Objectives**

---

### **Core Content Objectives**

---

Students will:

- ✓ Locate the Mississippi River on a map
- ✓ Locate the Rocky Mountains on a map
- ✓ Identify and locate the Louisiana Territory on a map
- ✓ Explain the significance of the Louisiana Territory and Purchase
- ✓ Explain the reasons that Lewis and Clark went on their expedition

### **Language Arts Objectives**

---

The following language arts objectives are addressed in this lesson. Objectives aligning with the Common Core State Standards are noted with the corresponding standard in parentheses. Refer to the Alignment Chart for additional standards addressed in all lessons in this domain.

Students will:

- ✓ Distinguish between information provided by an image of a red cedar and information provided in the read-aloud to determine why Lewis and Clark could not bring a red cedar back east (RI.1.6)
- ✓ Compare and contrast a grizzly bear and a black bear (RI.1.9)
- ✓ Make personal connections to Lewis and Clark's journals by creating journals of their own (W.1.8)
- ✓ Share writing with others

## Core Vocabulary

---

**hibernated, v.** Slept for the winter

*Example:* The bears hibernated in the cave.

*Variation(s):* hibernate, hibernates, hibernating

**journals, n.** Books kept to take down or record what happens on a daily basis, similar to diaries

*Example:* Lewis and Clark used journals to keep track of the new plants and animals they saw.

*Variation(s):* journal

**overturned, v.** Flipped upside down

*Example:* The cat overturned the bowl of water.

*Variation(s):* overturn, overturns, overturning

**record, v.** To write down information as a way of remembering or sharing

*Example:* During the meeting, Gwen used a notepad to record the information.

*Variation(s):* records, recorded, recording

**toppled, v.** Fell forward

*Example:* The box of cards toppled down the stairs.

*Variation(s):* topple, topples, toppling

### Vocabulary Chart for Red Cedars and Grizzly Bears

Core Vocabulary words are in **bold**.  
 Multiple Meaning Word Activity word is underlined.  
 Vocabulary Instructional Activity words have an asterisk (\*).  
 Suggested words to pre-teach are in *italics*.

Type of Words	Tier 3 Domain-Specific Words	Tier 2 General Academic Words	Tier 1 Everyday-Speech Words
<b>Understanding</b>	canoe evergreen <b>hibernated</b> plains	companion discovered <i>discoveries</i> flat/hilly frightening hollow gigantic <b>journals</b> task <b>topped</b>	animal black west wrote
<b>Multiple Meaning</b>	bark <b>overturned</b>	<b>record*</b> samples	bear branch feet parties plant shot
<b>Phrases</b>	<i>grizzly bears</i> <i>red cedars</i>	fished out keep a sharp eye out for parties of two or more would not stand a chance	
<b>Cognates</b>	canoa <b>hibernado</b>	compañero(a) descubierto <i>descubrimientos</i> gigantesco(a)	animal oeste partidos planta

**Note:** Introducing the Read-Aloud and Extensions may have activity options that exceed the time allocated for that part of the lesson. To remain within the time periods allocated for each portion of the lesson, you will need to make conscious choices about which activities to include based on the needs of your students.

Exercise	Materials	Details
<b>Introducing the Read-Aloud (10 minutes)</b>		
<b>Where Are We?</b>	<i>Frontier Explorers</i> Map; U.S. map	Have students find the landmarks on their own maps.
<b>What Have We Already Learned?</b>	Image Cards 11–13; Tasks Checklist	Use the Tasks Checklist to review the three tasks President Jefferson gave Lewis and Clark. Tell students that they will hear more about one of the tasks. Record what they find out about new plants and animals.
	Idea Web for Sacagawea	Review that Sacagawea was the group's guide and translator.
<b>Vocabulary Preview: Discoveries</b>	images of red cedar trees and grizzly bears	Preview the discoveries Lewis and Clark make in this part of their journey.
<b>Purpose for Listening</b>		
<b>Presenting the Read-Aloud (15 minutes)</b>		
<b>Red Cedars and Grizzly Bears</b>	Instructional Masters 9A-1 (Red Cedar) and 9A-2 (Grizzly Bear)	Have students fill in descriptions of these two new discoveries.
<b>Discussing the Read-Aloud (15 minutes)</b>		
<b>Comprehension Questions</b>	Images 9A-2 and 9A-4	
<b>Word Work: Record</b>		
 <b>Complete Remainder of the Lesson Later in the Day</b>		
<b>Extensions (20 minutes)</b>		
<b>Tracking Lewis and Clark and the Corps of Discovery</b>	<i>Frontier Explorers</i> Map; red crayon or marker; U.S. map	
<b>Explorer's Journal #7</b>	Instructional Master 9B-1; writing and drawing tools	

### ***Advance Preparation***

For *Vocabulary Preview*, find images of red cedar trees and grizzly bears to show students.

For *Presenting the Read-Aloud*, make copies of Instructional Masters 9A-1 and 9A-2 for each student. Have students use read-aloud information to fill in these activity pages about the red cedar and the grizzly bear.

Make a copy of Instructional Master 9B-1 for each student. This will be the seventh page of their *Explorer's Journal*. Students will record an event or discovery in their journals.

### ***Notes to Teacher***

Students may find the killing of the grizzly bears unsettling. Explain that many explorers during Lewis and Clark's time were skilled hunters and hunted for food to survive. Today, the grizzly bear is a threatened species; this means grizzly bears are likely to be endangered and may become extinct (such as the California grizzly) if they are not protected. To protect the grizzly bear includes limiting the killing of the grizzly bear.



# Red Cedars and Grizzly Bears

9<sub>A</sub>

**Note:** Introducing the Read-Aloud may have activity options that exceed the time allocated for this part of the lesson. To remain within the time periods allocated for this portion of the lesson, you will need to make conscious choices about which activities to include based on the needs of your students.

## ***Introducing the Read-Aloud***

**10** minutes

### **Where Are We?**

**5** minutes

Help students locate the Atlantic Ocean, the Appalachian Mountains, the Mississippi River, the Rocky Mountains, the Louisiana Purchase, the Missouri River, and the Pacific Ocean on a United States map.

### **What Have We Already Learned?**

**5** minutes

Review with students the three tasks Lewis and Clark were to accomplish on their expedition. You may wish to use Image Cards 11–13 when you talk about each task.

Discuss with students the previous read-aloud. Remind students that in the last read-aloud, Lewis and Clark spent the winter with the Mandan people and met Sacagawea, who they decided to hire as a translator and guide.

### **Vocabulary Preview**

**5** minutes

#### ***Discoveries***

1. In today's read-aloud, Lewis and Clark make two new *discoveries*.
2. Say the word *discoveries* with me three times.
3. Discoveries are things that are found and seen for the first time.



4. Lewis and Clark wrote about their new discoveries in their journals so that they could take the information back to President Jefferson.
5. [Show images of the red cedar and grizzly bear.] Lewis and Clark's discoveries at the time of today's read-aloud are red cedar trees and grizzly bears. Describe these discoveries to your partner.

### **Purpose for Listening**

---

Tell students that in today's read-aloud, Lewis and Clark will make more discoveries on their expedition. Tell students to listen to find out what Lewis and Clark discover and how they keep track of what they discover.



## Red Cedars and Grizzly Bears

### ← Show image 9A-1: Parting ways

After Lewis and Clark sent some of the team back east with reports and scientific samples for President Jefferson, the captains and the rest of their crew continued west. They rode in two of their original pirogues plus six new canoes made from hollowed-out trees. These canoes, about thirty feet long and three feet wide, were hard to balance. More than once, as the men were getting used to them, the canoes **overturned** in mid-river, forcing the men to fish out wet supplies before going on.<sup>1</sup> Despite this, Lewis wrote in his journal that the men were happy and healthy.

1 The men had to get the supplies out of the water because the boats flipped over in the water and the supplies fell out.



### ← Show image 9A-2: Missouri River lined with Western red cedars

Soon they left behind the flat plains and entered hilly land. Now, the Missouri River became more difficult to travel. Forests of western red cedars lined the banks of the river. These beautiful trees were so important to the Native Americans of the area that some of the Native Americans called themselves “the people of the red cedar,” performing special ceremonies before chopping down the huge evergreens.<sup>2</sup>

2 An evergreen tree remains green all year long.



### ← Show image 9A-3: Men gathered around a red cedar to show size

Lewis and Clark knew it would be impossible to take an entire tree back with them because of its gigantic size, almost 200 feet above the ground. That’s as tall as a twenty-story building! Nevertheless, the tree was so important to the lives of the Native Americans that they knew they must gather samples and **record**<sup>3</sup> its many uses. They drew pictures and collected branches, cones, and seeds.

3 or take notes on

As they learned more about the western red cedar from the Native Americans in the area, both Lewis and Clark wrote about the importance of the western red cedar in their **journals**.<sup>4</sup> The people and animals of the northwest relied upon the tree for their

4 A journal is a book in which you can write notes or stories or draw pictures.

existence. The Native Americans used the bark of the tree to weave mats, baskets, and clothing, and used the wood to build canoes. Elk ate the leaves and shoots of the enormous tree. Bears **hibernated**, or slept through the winter, in hollow cedar logs.



← **Show image 9A-4: Grizzly bear and Eastern black bear**

5 [Point to the grizzly bear in the picture.] What do you think Clark means when he says, “Keep a sharp eye out for grizzly bears”?

6 Does Captain Clark think that grizzly bears are like black bears? (No, grizzly bears are much larger and fiercer.)

The men heard often of the bears called grizzly bears that made their homes in the hollowed-out logs of the cedars, so as they made their way up the Missouri, William Clark warned, “Keep a sharp eye out for grizzly bears.”<sup>5</sup>

One of the hunters said, “Don’t worry, Captain, we’ve seen plenty of bears before, back in Kentucky.”

“Black bears, yes; grizzly bears, no. From what I hear, it’s like the difference between a house cat and a lion.”<sup>6</sup>



← **Show image 9A-5: Meeting grizzlies**

One day, Lewis and another man were out hunting along the riverbank. Suddenly they saw two giant grizzly bears up ahead. The bears rose up on their hind legs—up and up—until they stood *eight feet tall!* Then, roaring, the bears charged—or ran towards them. Raising their rifles and taking careful aim, Lewis and his companion<sup>7</sup> shot one bear, but missed the other bear.

“Run!” shouted Lewis, and the two men turned and ran for their lives!

Lewis and his friend stopped running to take another shot at the bear. There was a nervous and uneasy moment as the bear suddenly stopped running. It held still for a moment, and then it **toppled over**.<sup>8</sup>

7 or friend

8 or fell forward



← **Show image 9A-6: Examining the dead grizzly bear**

Only when they were sure that the grizzly bear was dead did Lewis and his companion carefully approach the animal. Lewis later wrote in his journal that the bear weighed between five hundred and six hundred pounds, and was eight and a half feet tall. That’s taller than two first graders, one standing on top of the other!

After this frightening chase, Lewis told the whole party, “From now on, we must always move about, and do even the simplest actions, in parties<sup>9</sup> of two or more. One man alone going up against a grizzly would not stand a chance.”

## Discussing the Read-Aloud

15 minutes

### Comprehension Questions

10 minutes



1. *Literal* Which task or tasks did Lewis and Clark accomplish in the story today? (They discovered a new plant and animal.)

← Show image 9A-2: Missouri River lined with Western red cedars

2. *Inferential* What was one plant that Lewis and Clark discovered? (Lewis and Clark discovered the red cedar.) Describe the red cedar. (The red cedar is very tall and has needles. It is an evergreen tree.)
3. *Inferential* Could Lewis and Clark bring a red cedar back with them? (No, they could not.) Why not? (It was too big.) What did they decide to do instead? (Instead, they decided to draw pictures and collect cones and branches.)



← Show image 9A-4: Grizzly bear and Eastern black bear

4. *Evaluative* What was the animal that Lewis and Clark discovered? [Students should point to the grizzly bear.] How are the two bears the same? (They are both bears.) How are they different? (The black bear is smaller and black. The grizzly bear is brown and much bigger.)
5. *Inferential* Why did Lewis tell the group they must do things in parties of two or more? (They should do things in parties of two or more because of the danger of grizzly bears.)

[Please continue to model the *Think Pair Share* process for students, as necessary, and scaffold students in their use of the process.]

I am going to ask a question. I will give you a minute to think about the question, and then I will ask you to turn to your neighbor and discuss the question. Finally, I will call on several of you to share what you discussed with your partner.

6. *Evaluative Think Pair Share:* Which of the two discoveries did you find more interesting: the grizzly bear or the red cedar? Why? (Answers may vary.)
7. After hearing today’s read-aloud and questions and answers, do you have any remaining questions? [If time permits, you may wish to allow for individual, group, or class research of the text and/or other resources to answer these questions.]

### Word Work: Record

5 minutes

1. In the read-aloud you heard, “Nevertheless, the [western red cedar] was so important to the lives of the Native Americans that [Lewis and Clark] knew they must gather samples and *record* its many uses.”
2. Say the word *record* with me.
3. When you record something that means you write it down or keep track of it.
4. Lewis and Clark were told to record information about the new plants and animals they discover in their journals.
5. Pretend that you were on the expedition with Lewis and Clark. What kinds of things would you record on the expedition? [Ask two or three students. If necessary, guide and/or rephrase students’ responses: “I would record \_\_\_\_\_ because . . . ”]
6. What’s the word we’ve been talking about?

Use a *Word to World* activity for follow-up. Directions: With your partner, think of other actions that are similar to record. (write, draw, log, jot down, list, tape, video)

With your partner, think of items you would need in order to record something. (pencil, pen, markers, paper, journal, tape recorder, video recorder)



### Complete Remainder of the Lesson Later in the Day

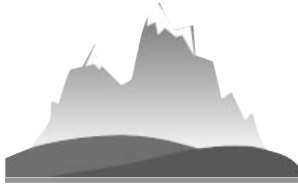

# Red Cedars and Grizzly Bears

9<sub>B</sub>

**Note:** Extensions may have activity options that exceed the time allocated for this part of the lesson. To remain within the time periods allocated for this portion of the lesson, you will need to make conscious choices about which activities to include based on the needs of your students.

## ***Extensions***

**20** *minutes*

### **Tracking Lewis and Clark and the Corps of Discovery**

**10** *minutes*

- Review the areas students have colored in—the area of the United States at the time of the read-aloud (in orange), the Appalachian Mountains, the Rocky Mountains, the Mississippi River, and the Missouri River.
- Remind students that Lewis and Clark started their journey in the town of St. Louis. Have students put their finger on the dot that represents St. Louis on their maps.
- Then, have students follow the red X's along the Missouri River and stop at the first dot. Ask: “What area of the United States is this area called?” (the prairie/the Great Plains)
- Then, have students continue to follow the red X's along the Missouri River and stop at the second dot. Remind students that in the previous read-aloud, Lewis and Clark met two other Native American groups (the Hidatsa and the Mandan) as well as Sacagawea.
- Next, have students draw red X's to the third dot, where today's read-aloud took place. Ask: “What new discoveries did Lewis and Clark make here?” (the red cedar and the grizzly bear)
- Ask: “Are they getting closer to the Rocky Mountains? Are they closer to the Appalachian Mountains or the Rocky Mountains? Are they closer to the Pacific Ocean or the Atlantic Ocean?” Be sure that students use their maps to answer the questions.

- Remind students that Lewis and Clark recorded all of their discoveries and events in a journal. Tell students they will continue to draw and write in their journals.
- Have students pretend that they are one of the members of the Corps of Discovery traveling with Lewis and Clark. They will continue to record interesting things that they have seen or experienced.
  - First, have them think about everything they have heard about Lewis and Clark's travels over the past few days. [Use Flip Book images from Lessons 7–9 to refresh their memory of events that happened.]
  - Next, have students choose an event or discovery to write about in their journals.
  - Then, have them draw a picture of the event or discovery and write several sentences about that event or discovery.
  - Finally, have students share their drawings and writing with their partner or home-language peers.

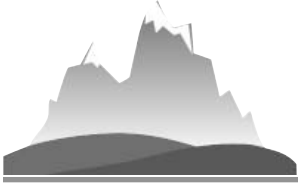

## ✓ **Lesson Objectives**

---

### **Core Content Objectives**

---

Students will:

- ✓ Locate the Mississippi River on a map
- ✓ Locate the Rocky Mountains on a map
- ✓ Identify and locate the Louisiana Territory on a map
- ✓ Explain the significance of the Louisiana Territory and Purchase
- ✓ Explain the reasons that Lewis and Clark went on their expedition
- ✓ Explain that there were many, many Native American tribes already living in the Louisiana territory before the Lewis and Clark expedition
- ✓ Recall basic facts about Lewis and Clark’s encounters with Native Americans
- ✓ Explain why and how Sacagawea helped Lewis and Clark

### **Language Arts Objectives**

---

The following language arts objectives are addressed in this lesson. Objectives aligning with the Common Core State Standards are noted with the corresponding standard in parentheses. Refer to the Alignment Chart for additional standards addressed in all lessons in this domain.

Students will:

- ✓ Ask and answer *what* questions orally, requiring literal recall and understanding of the details and facts from “Rivers and Mountains” (SL.1.2)
- ✓ Explain the meaning of “if at first you don’t succeed, try, try again” and use in appropriate contexts (L.1.6)



## Core Vocabulary

**confidently, adv.** With confidence; being sure of yourself  
*Example:* At the concert, the boy confidently sang the song.  
*Variation(s):* none

**dull, adj.** Boring; not exciting  
*Example:* The movie was very dull and very long.  
*Variation(s):* duller, dullest

**sign language, n.** A language or form of communication using one's hands  
*Example:* While the story was read out loud, someone also told it using sign language.  
*Variation(s):* sign languages

**waterfall, n.** A place where a river falls from a high point or over a cliff  
*Example:* There is a very famous waterfall in both the United States and Canada called Niagara Falls.  
*Variation(s):* waterfalls

Vocabulary Chart for Rivers and Mountains			
Core Vocabulary words are in <b>bold</b> . Multiple Meaning Word Activity word is <u>underlined</u> . Vocabulary Instructional Activity words have an asterisk (*). Suggested words to pre-teach are in <i>italics</i> .			
Type of Words	Tier 3 Domain-Specific Words	Tier 2 General Academic Words	Tier 1 Everyday-Speech Words
<b>Understanding</b>	captain pirogue Sacagawea Shoshone <b>waterfall</b>	<b>confidently</b> explained following recognized spied	boat brother friend/friendly* horse mountain ocean river
<b>Multiple Meaning</b>	chief	<b>dull*</b> reached split supply	foot <u>fork</u>
<b>Phrases</b>	Corps of Discovery Missouri River Pacific Ocean Rocky Mountains <b>sign language</b>	depend on	
<b>Cognates</b>	capitán jefe	<b>confidentemente</b> explicado reconocido	bote montaña océano

**Note:** Introducing the Read-Aloud and Extensions may have activity options that exceed the time allocated for that part of the lesson. To remain within the time periods allocated for each portion of the lesson, you will need to make conscious choices about which activities to include based on the needs of your students.

Exercise	Materials	Details
<b>Introducing the Read-Aloud (10 minutes)</b>		
Where Are We?	Frontier Explorers Map; U.S. map	Have students find the landmarks on their own maps.
What Have We Already Learned?	Idea Web for Sacagawea	Review that Sacagawea was a guide and a translator for Lewis and Clark’s team.
	Image Cards 11–13; Tasks Checklist	Use the Tasks Checklist to review the three tasks President Jefferson gave Lewis and Clark. Ask students which two tasks they have accomplished. (discovering new plants and animals; making friendships with the Native Americans)
Vocabulary Preview: Waterfall	pictures and short video clips of waterfalls (e.g., Niagara Falls, waterfalls in the Rocky Mountains)	
Purpose for Listening		
<b>Presenting the Read-Aloud (15 minutes)</b>		
Rivers and Mountains		
<b>Discussing the Read-Aloud (15 minutes)</b>		
Comprehension Questions	Tasks Checklist	Use this to answer Question #3.
	Idea Web for Sacagawea	Add to this Idea Web during Questions #4 (translated the language of the Shoshone tribe to English) and #5 (the Shoshone chief was her brother)
Word Work: Dull		
 <b>Complete Remainder of the Lesson Later in the Day</b>		

Exercise	Materials	Details
<b>Extensions (20 minutes)</b>		
<b>Multiple Meaning Word Activity: Fork</b>	Poster 5M (Fork)	
<b>Syntactic Awareness Activity: Sentence Types</b>	Punctuation Marks; Images 10A-4 and 10A-11	
<b>Vocabulary Instructional Activity: Friendly</b>	Image 10A-9; chart paper, index cards, tape, marker	
<b>Sayings and Phrases: If at First You Don't Succeed, Try, Try Again</b>		
<b>Tracking Lewis and Clark and the Corps of Discovery</b>	Image Cards 15–22; <i>Frontier Explorers</i> Map; red crayon or marker; U.S. map	
<b>Domain-Related Trade Book</b>	trade book about Sacagawea; drawing paper, drawing and writing tools	Trade book suggestions: Items 4, 12, and 14

### **Advance Preparation**

For *Vocabulary Preview*, find pictures of waterfalls and short video clips of waterfalls (e.g., Niagara Falls and waterfalls in the Rocky Mountains) to show students.

For the *Vocabulary Instructional Activity*, create a Horizontal Word Wall by drawing a horizontal line from left to right on a large piece of chart paper. Write each of the following words on an individual index card: *friendly, kind, nice, warm, neighborly, helpful, welcoming, unfriendly, mean, unhelpful, cold, rude, and hostile*.

Find a trade book about Sacagawea to read aloud to the class.

### **Notes to Teacher**

You may wish to pause and do the following during the read-aloud:

After reading the section for Image 10A-2, review the problem that the group faced—they were not sure which river was the Missouri River.

After reading the section for Image 10A-5, invite students to describe what a waterfall is. Emphasize that the group had difficulty carrying their things around the waterfalls.

After reading the section for Image 10A-8, be sure that students understand that Lewis found out that there was no all-water route to the Pacific Ocean, because the river did not flow down from the mountain into the ocean as he had expected.

After reading the section for Image 10A-10, ask students why Sacagawea suddenly cried out as she was translating for the Shoshone chief. (The chief was her brother.)



# Rivers and Mountains

10<sub>A</sub>

**Note:** Introducing the Read-Aloud may have activity options that exceed the time allocated for this part of the lesson. To remain within the time periods allocated for this portion of the lesson, you will need to make conscious choices about which activities to include based on the needs of your students.

## ***Introducing the Read-Aloud***

**10** minutes

### **Where Are We?**

5 minutes

Help students locate the Atlantic Ocean, the Appalachian Mountains, the Mississippi River, the Rocky Mountains, the Louisiana Purchase, the Missouri River, and the Pacific Ocean on a United States map.

### **What Have We Already Learned?**

5 minutes

Review with students the reasons why Lewis and Clark decided to bring Sacagawea on the expedition with them. (translator, guide)  
Review the term *translator* with students.

Review with students the three tasks that President Jefferson had asked Lewis and Clark to accomplish on their expedition. You may wish to use Image Cards 11–13 when you talk about each task.

### **Vocabulary Preview**

5 minutes

#### ***Waterfall***

1. In today's read-aloud, Lewis and Clark tried to find a *waterfall* on the Missouri River.
2. Say the word *waterfall* with me three times.
3. A waterfall is a place where a river falls from a high point or over a cliff.
4. [Show a picture of Niagara Falls.] There is a famous waterfall in the United States and Canada called Niagara Falls. Do you

see the high point or cliff where the river drops?

5. [Show additional pictures of waterfalls.] Have you ever seen a waterfall in real-life before? How would you describe the waterfall in this picture?

[If time permits, show short video clips of waterfalls. Have students describe how the waterfalls look and sound.]

### **Purpose for Listening**

---

Tell students that in today's read-aloud, Lewis and Clark will try to accomplish their last task—to find an all-water route to the Pacific Ocean. Tell students to listen carefully to find out whether they can accomplish this task.



## Rivers and Mountains

### ← Show image 10A-1: John Shields and George Shannon paddling ahead

1 Can you imagine traveling and being away from home for a year?

2 Which events do you think they were talking about?

3 *Dull* means boring. No one can say that this expedition has been boring.

The Corps of Discovery had now been on their journey for over a year.<sup>1</sup> The explorers were very good friends with one another and had learned to depend on one another. One day, John Shields and George Shannon went ahead of the others in a pirogue. John Shields was the blacksmith, and he knew his way around outdoors. George Shannon was smart and friendly.

Shields and Shannon paddled up the river, talking over the exciting events they had gone through so far.<sup>2</sup> “Well,” Private Shannon said, “no one can complain that it has been **dull**.”<sup>3</sup>



### ← Show image 10A-2: A fork in the river

No sooner were those words out of his mouth than the tip of their pirogue came around a bend in the river, and they saw a sight that caused them to stop paddling for a moment. Up ahead, the Missouri River split into two wide rivers. One of the two rivers was the Missouri, and the other was not. It was impossible to tell which one was the Missouri River. “Which river is the Missouri?” Shannon asked. “The Missouri River is the one the captains think can carry us farther west.”

“I don’t know,” Shields replied, “and I don’t think the captains will know either.”

“We’ve passed the part of the river our Native American friends told us about, and none of us has seen this part of the country before.”

Soon the other boats arrived. Going ashore, Lewis and Clark walked ahead and inspected the two rivers. Clark said, “If we take the wrong river, it may turn too cold for us to travel by the time we are ready to start from here again.”



← **Show image 10A-3: Map of Lewis and Clark's journey so far**<sup>4</sup>

- 4 [Point out that Lewis and Clark's path so far is shown in red.]
- 5 Which one of the three tasks do you think Lewis and Clark will not be able to accomplish?
- 6 [Remind students that Sacagawea was Shoshone.]

The Native Americans told them that the Missouri River ended in the Rocky Mountains. Lewis and Clark knew that they would have to travel by land instead of by water to cross the mountains.<sup>5</sup>

“We need to find the Shoshone people up ahead, so we can buy horses from them,” they agreed.<sup>6</sup> But first they would have to continue along the Missouri River to the Rocky Mountains.



← **Show image 10A-4: Going exploring**

- 7 [Explain to students that a waterfall is a place where the river falls from a high cliff.]
- 8 The fork is where the river split into two rivers. The word *fork* also has other meanings. The word *fork* also means a tool you use to eat food.
- 9 Who do you think will find the waterfall: Lewis or Clark?

Lewis suggested, “The last Native Americans we talked to said that there was a huge **waterfall** up ahead on the Missouri River.<sup>7</sup> We need to find that waterfall. Take some men along the south fork, Clark, and I’ll try the north.<sup>8</sup> If one of us finds it, that person will know he is on the correct river. We’ll meet back here in a few days to see which group has found the waterfall.”<sup>9</sup>

Unfortunately when they met back up after a few days, neither group had found the waterfall. Lewis had another idea. He decided to try looking for the waterfall by land, rather than following one of the two rivers.



← **Show image 10A-5: Waterfall**<sup>10</sup>

- 10 [Point to the waterfall.]

Lewis and his men walked for two days before they heard what Lewis later described as “the agreeable sound of falling water.” Following the sound, they came to not just one waterfall, but a whole series of great waterfalls. This was it! They could now figure out which of the two rivers was the Missouri River. Lewis sent a man back for the rest of the party. When Clark and the rest arrived at the great waterfalls, however, they found Lewis and his men burying the keelboat and some of their supplies for the trip back. “It’s too heavy,” Lewis explained. “We need to carry the boats around the waterfalls in order to continue up the Missouri River.”

Finally, after eleven days of hard work, they left the great waterfalls behind. It was a difficult journey. The river was becoming harder to follow as it narrowed and filled with rocks.





← **Show image 10A-6: Sacagawea guiding the party**

On the other hand, Sacagawea was closer to the area where she had lived with the Shoshone. She was now able to guide the Corps of Discovery better, because she started to recognize the land where she had lived as a child. The more places she recognized, the more **confidently** she guided them.<sup>11</sup>

11 Sacagawea became more certain of which way to go as she got closer to the Shoshone lands where she used to live.

In August of 1805, Lewis told Clark, “I will take three men ahead on foot, instead of following this winding river. If we find the Shoshone, we’ll return with horses. We can use the horses to cross the mountains. Then we can look for the other river we think flows down from the mountains all the way to the Pacific Ocean.”



← **Show image 10A-7: Meeting a Shoshone horseman**

A few days later, Lewis and his men were crossing a meadow when they spied a Shoshone horseman up ahead.<sup>12</sup> Unfortunately, when he saw Lewis and his men, the Shoshone horseman turned and rode away.

12 *Spied* means they saw a Shoshone horseman.



← **Show image 10A-8: Map of Lewis and Clark's journey so far**

The four men kept looking for the Shoshone. A few days later, they reached the Rocky Mountains.<sup>13</sup> They climbed a part of the mountain. Then Lewis looked down from a peak. He expected to see a large river flowing out of the mountains into the Pacific Ocean, but all he saw were more mountains! Lewis found out that there was no all-water route to the Pacific Ocean after all.

13 [Point to the Rocky Mountains on the image. Remind students that the Louisiana Purchase went from the Mississippi River to the Rocky Mountains.]



← **Show image 10A-9: Meeting the Shoshone chief**

The next afternoon, they came upon an old Shoshone woman gathering wood for a fire. Smiling, Lewis said in English, “We are friends.” She did not know English, but she understood when Lewis smiled that he was friendly. She led the four travelers to her village and introduced Lewis to the chief. The Shoshone had plenty of horses, but the Shoshone chief explained with **sign language** that the Shoshone did not have much food to share.<sup>14</sup>

14 Sign language is a way of communicating by using your hands.

Two days later, Clark and the rest of the expedition arrived with Sacagawea.



15 Remember, when Sacagawea translated, she turned the chief's words in the Shoshone language into English so that Lewis and Clark could understand.

← **Show image 10A-10: Talking with the chief by the fire**

Now Sacagawea could translate the chief's words.<sup>15</sup> Sacagawea joined Lewis, Clark, and the chief in his cabin. It was dark; the only light was from the fire. With her help, the chief told the captains that his people did not know the way to the ocean, but that a river did run down to it, and that another tribe, the Nez Perce, could lead the party to the river. As she translated this, Sacagawea suddenly cried out. In the shadows of the chief's home, she had not seen his face clearly. Now, as he turned more toward the light, she recognized him.

The chief was Sacagawea's brother!



16 Sacagawea and her brother had not seen each other in many years.

← **Show image 10A-11: Reunion of Sacagawea and her brother**

She threw her arms around him and in a rush of words explained who she was. What a joyful surprise this was for everyone!<sup>16</sup> In all the Shoshone lands, Lewis had stumbled into the village of Sacagawea's brother. Now the chief said, "My sister, I will help you and your friends get all the horses, supplies, and guides you will need in order to complete your journey."

## Discussing the Read-Aloud

**15** minutes

### Comprehension Questions

**10** minutes

1. *Inferential* Have Lewis and Clark and the Corps of Discovery been on their expedition for a short time or a long time? (a long time, over one year)
2. *Inferential* How were Lewis and Clark able to find out which of the two rivers was the Missouri River? (the Missouri River had a waterfall)
3. *Literal* Which task did Lewis and Clark discover they would not be able to accomplish? (Lewis and Clark would not be able to find an all-water route to the Pacific Ocean.)
4. *Literal* What was Sacagawea's job once the Corps of Discovery reached the Shoshone? (Sacagawea was the translator once the Corps of Discovery reached the Shoshone.)

5. *Literal* Who was the Shoshone chief? (Sacagawea’s brother was the Shoshone chief.)
6. *Inferential* Describe how the Shoshone acted toward the explorers. (The Shoshone were friendly and gave them supplies, horses, and guides to help them.)

[Please continue to model the *Question? Pair Share* process for students, as necessary, and scaffold students in their use of the process.]

7. *Evaluative What? Pair Share:* Asking questions after a read-aloud is one way to see how much everyone has learned. Think of a question you can ask your neighbor about the read-aloud that starts with the word *what*. For example, you could ask, “What did you learn about in today’s read-aloud?” Turn to your neighbor and ask your *what* question. Listen to your neighbor’s response. Then your neighbor will ask a new *what* question, and you will get a chance to respond. I will call on several of you to share your questions with the class.
8. After hearing today’s read-aloud and questions and answers, do you have any remaining questions? [If time permits, you may wish to allow for individual, group, or class research of the text and/or other resources to answer these questions.]

### Word Work: Dull

5 minutes

1. In the read-aloud you heard Private Shannon say, “No one could complain that [the trip] has been *dull*.”
2. Say the word *dull* with me.
3. *Dull* means boring or not exciting.
4. I had already seen this movie, so I found it very dull to watch again.
5. What is opposite of dull?  
[Ask two or three students. If necessary, guide and/or rephrase students’ responses. “\_\_\_\_\_ is opposite of dull.” (exciting, fun, lively, interesting)]
6. What’s the word we’ve been talking about?

Use a *Making Choices* activity for follow-up. Directions: I will name a few activities. If you think the activity I name would be dull, say, “That would be dull.” If you think the activity I name would be exciting, say, “That would be exciting.” Different people find different things dull or exciting, so remember that everyone might have a different response. Explain to your partner why you find a certain activity dull or exciting.

1. reading a chapter book
2. swimming at the beach
3. going on a roller coaster
4. sledding down a hill
5. learning a new math concept
6. taking care of a baby animal
7. learning to play an instrument



**Complete Remainder of the Lesson Later in the Day**



# Rivers and Mountains

10<sub>B</sub>

**Note:** Extensions may have activity options that exceed the time allocated for this part of the lesson. To remain within the time periods allocated for this portion of the lesson, you will need to make conscious choices about which activities to include based on the needs of your students.

## Extensions

20 minutes

### ↔ Multiple Meaning Word Activity

5 minutes

#### *Sentence in Context: Fork*

**Note:** You may choose to have students hold up one or two fingers to indicate which image shows the meaning being described, or have a student walk up to the poster and point to the image being described.

1. [Show Poster 5M (Fork).] In the read-aloud you heard Lewis tell Clark, “Take some men along the south *fork*, and I’ll go north.” Here *fork* means a place where something, such as a road or river, splits into two parts. Which picture shows this kind of *fork*?
2. Fork is also something that you use for eating food. Which picture shows this kind of *fork*?
3. With your partner, make up a sentence for each meaning of *fork*. I will call on some of you to share your sentences. [Call on a few partner pairs to share one or all of their sentences. Have them point to the part of the poster that relates to their use of *fork*.]

## ↔ Syntactic Awareness Activity

5 minutes

### *Sentence Types*

**Note:** The purpose of these syntactic activities is to help students understand the direct connection between grammatical structures and the meaning of text. These syntactic activities should be used in conjunction with the complex text presented in the read-alouds. There may be variations in the sentences created by your class. Allow for these variations, and restate students' sentences so that they are grammatical. If necessary, have students repeat the sentence after you.

Please change the inflection of your voice to match the punctuation of the sentences you read aloud. Have students hold up the end punctuation for the sentences.



#### ← Show image 10A-4: Going exploring

1. What are the three types of sentences we use? Hold up the punctuation we use for each type. (sentences that give information/period; sentences that ask questions/question mark; sentences that exclaim something/exclamation point)
2. I am going to say several sentences about this image. Repeat the sentence after me, and hold up the correct punctuation mark to show what type of sentence it is.
  - Which river is the Missouri River? (question mark)
  - Let's split into two groups to find the waterfall. (period)
  - It's been a few days, and we still haven't found the waterfall! (exclamation point)

Now you try! Say a sentence about this image to your partner. Then your partner should hold up the correct punctuation mark to show what type of sentence it is. Then, switch roles. I will call on a few of you to share your sentences with the class.



#### ← Show image 10A-11: Reunion of Sacagawea and her brother

3. I am going to say several sentences about this image. Repeat the sentence after me, and hold up the correct punctuation mark to show what type of sentence it is.

- Are you my brother? (question mark)
- You are my brother! (exclamation point)
- Sacagawea and the Shoshone chief are siblings. (period)

Now you try! Say a sentence about this image to your partner. Then your partner should hold up the correct punctuation mark to show what type of sentence it is. Then, switch roles. I will call on a few of you to share your sentences with the class.

## ↔ Vocabulary Instructional Activity

5 minutes



### Horizontal Word Wall: Friendly

#### ◀ Show image 10A-9: Meeting the Shoshone chief

1. In today's read-aloud you heard that the Shoshone acted *friendly* towards the explorers and gave them supplies, horses, and guides.
2. *Friendly* means kind and helpful.
3. Let's create a Horizontal Word Wall that describes how people act towards each other. [Show students the chart paper, and point out the horizontal line.]
4. [Hold up the card for the word *nice*, and read the word aloud.] *Nice* means thoughtful of others and kind. [Tape the card for *nice* towards the right-hand side of the line.]
5. [Hold up the card for the word *mean*, and read the word aloud.] *Mean* means not nice. [Tape the card for *mean* towards the left-hand side of the line.]
6. [Hold up the card for the word *friendly*, and read the word aloud.] Should the word *friendly* be placed closer to the word *mean* or the word *nice*? [Tape the card near the word *nice*.]
7. [Repeat this process with the remaining cards so that the end result is a horizontal word wall that shows from right to left: *friendly, kind, nice, warm, neighborly, helpful, welcoming, unfriendly, mean, unhelpful, cold, rude, and hostile*. When all the cards have been attached to the word wall, read over the words with students.]

[Display the Horizontal Word Wall throughout the domain, and encourage students to add additional words to the wall.]

## Sayings and Phrases:

### If at First You Don't Succeed, Try, Try Again

5 minutes

**Note:** Proverbs are short, traditional sayings that have been passed along orally from generation to generation. These sayings usually express general truths based on experiences and observations of everyday life. While some proverbs do have literal meanings—that is, they mean exactly what they say—many proverbs have a richer meaning beyond the literal level. It is important to help your students understand the difference between the literal meanings of the words and their implied, or figurative, meanings.

- Ask students if they have ever heard the saying “if at first you don’t succeed, try, try again.” Explain to students that the saying means that you shouldn’t stop trying even if you fail at something the first time. Have students repeat the saying after you.
- Explain to students that in the read-aloud today, they heard about the problems Lewis and Clark encountered when the river divided into two parts and they had to figure out which river to continue following. They knew that the correct river would have a waterfall, so they decided to try and find the waterfall. First, they tried splitting up and going down each of the two rivers to find the waterfall, but they did not succeed in finding it. However, they did not give up. Lewis and Clark may have said, “If at first you don’t succeed, try, try again.” They tried walking over land to find the waterfall, and this time they did find the waterfall! If Lewis and Clark had given up after their first try, they would never have found the waterfall. So, just because their first try was unsuccessful, Lewis and Clark did not give up; they tried a second time—and were successful!
- Have students share experiences in which they failed at something at first, but then kept trying until they were successful.



## Tracking Lewis and Clark and the Corps of Discovery 10 minutes

---

- Have students point to the place where Lewis and Clark and the Corps of Discovery started their journey. (St. Louis)
- Then have students follow the red X's along the Missouri River until they reach the first dot. Ask students: "What area were they in at this point in their expedition?" (the prairie, the Great Plains) Remind students that this is where they met the Yankton Sioux (YANGK-tuhn sooz) (Image Card 17) and the Teton Sioux (TEE-ton sooz) (Image Card 18). This is also where they discovered the antelope (Image Card 15) and the prairie dog (Image Card 16).
- Then, have students continue to follow the Missouri River with their finger to the second dot. Ask students: "Who did Lewis and Clark meet here? Who joined their team?" (Toussaint Charbonneau and Sacagawea) (Image Card 20) This is also where they met the Hidatsa and Mandan tribes (Image Card 19).
- Again, have students follow the Missouri River with their finger until they come to the third dot on their maps. Remind students that this was where Lewis and Clark discovered the western red cedar (Image Card 22) and encountered the grizzly bears (Image Card 21) in the previous read-aloud.
- Now, have students follow the Missouri River even closer to the Rocky Mountains and into the Rocky Mountains. Have students draw red X's along the Missouri River up to the fourth dot, where today's read-aloud takes place. Remind students that Lewis and Clark met the Shoshone and received much help from this tribe.
- Point out that they started in St. Louis and traveled along the Missouri River. Ask: "Where are Lewis and Clark now? How close are they to the Pacific Ocean?" Be sure that students use their maps to answer the questions.

## Domain Related Trade Book 20+ minutes

---

- Refer to the list of recommended trade books in the Introduction at the front of this Supplemental Guide, and choose one trade book about Sacagawea to read aloud to the class. [Suggested trade books are items on the list numbered 4, 12, and 14.]

- Explain to students that the person who wrote the book is called the author. Tell students the name of the author. Explain to students that the person who makes the pictures for the book is called an illustrator. Tell students the name of the illustrator. Show students where they can find this information on the cover of the book or on the title page.
- As you read, use the same strategies that you have been using when reading the read-aloud selections—pause and ask text-based questions to ensure comprehension; rapidly clarify critical vocabulary within the context of the read-aloud; etc.
- After you finish reading the trade book aloud, lead students in a discussion as to how the story or information in this book relates to the read-alouds in this domain. Discuss whether the trade book was fiction or nonfiction, fantasy or reality, historical or contemporary.
- Provide students with drawing paper, drawing tools and writing tools. Have students draw one detail they remember from the trade book. Students may also draw one new thing that they learned from the trade book that they did not know before. Students should label their pictures and write a sentence to go along with their drawings. Have students share their drawings and writing with their partner or with home-language peers.



# To the Pacific and Back

11

## ✓ **Lesson Objectives**

---

### **Core Content Objectives**

---

Students will:

- ✓ Locate the Mississippi River on a map
- ✓ Locate the Rocky Mountains on a map
- ✓ Identify and locate the Louisiana Territory on a map
- ✓ Explain the significance of the Louisiana Territory and Purchase
- ✓ Explain the reasons that Lewis and Clark went on their expedition
- ✓ Explain that there were many, many Native American tribes already living in the Louisiana territory before the Lewis and Clark expedition
- ✓ Recall basic facts about Lewis and Clark's encounters with Native Americans

### **Language Arts Objectives**

---

The following language arts objectives are addressed in this lesson. Objectives aligning with the Common Core State Standards are noted with the corresponding standard in parentheses. Refer to the Alignment Chart for additional standards addressed in all lessons in this domain.

Students will:

- ✓ Make personal connections to Lewis and Clark's journals by creating journals of their own (W.1.8)
- ✓ Use the antonyms *contentment* and *discontentment* appropriately in oral language (L.1.5a)
- ✓ Share writing with others

## Core Vocabulary

---

**canyons, n.** Long, narrow valleys with steep sides

*Example:* A river runs through the canyons.

*Variation(s):* canyon

**communities, n.** Groups of people who live together in the same place

*Example:* The large city was made up of many small communities.

*Variation(s):* community

**contentment, n.** Happiness and satisfaction

*Example:* The explorers felt contentment after their successful expedition.

*Variation(s):* none

**current, n.** A strong flow of water moving in a particular direction

*Example:* The current moved the canoe down the river.

*Variation(s):* currents

**steered, v.** Guided or directed the movement of something

*Example:* The sailor steered the ship away from the large rock in the ocean.

*Variation(s):* steer, steers, steering

### Vocabulary Chart for To the Pacific and Back

Core Vocabulary words are in **bold**.  
 Multiple Meaning Word Activity word is underlined.  
 Vocabulary Instructional Activity words have an asterisk (\*).  
 Suggested words to pre-teach are in *italics*.

Type of Words	Tier 3 Domain-Specific Words	Tier 2 General Academic Words	Tier 1 Everyday-Speech Words
<b>Understanding</b>	canoe/canoeist <b>canyons</b> <b>communities</b> expedition pirogues mapped Sacagawea Shoshones Nez Perce	accomplish amazed <b>contentment*</b> explore safely <b>steered</b> task	boat friend home river whale
<b>Multiple Meaning</b>		control <b>current</b> settled sight	rock water
<b>Phrases</b>	all-water route James Monroe Louisiana Territory Meriwether Lewis Pacific Ocean Rocky Mountains Thomas Jefferson William Clark	just short of keeping their balance the closer . . . the more . . .	head for home make it back home
<b>Cognates</b>	canoa <b>cañones</b> <b>comunidades</b> expedición piragua	<b>contentamiento*</b> explorar	bote

**Note:** Introducing the Read-Aloud and Extensions may have activity options that exceed the time allocated for that part of the lesson. To remain within the time periods allocated for each portion of the lesson, you will need to make conscious choices about which activities to include based on the needs of your students.

Exercise	Materials	Details
<b>Introducing the Read-Aloud (10 minutes)</b>		
Where Are We?	Frontier Explorers Map; U.S. map	Have students find the landmarks on their own maps.
What Have We Already Learned?	Image Cards 11–13; Tasks Checklist	
Vocabulary Preview: Canyons	Image 11A-1; pictures of canyons (e.g., the Grand Canyon)	
Purpose for Listening		
<b>Presenting the Read-Aloud (15 minutes)</b>		
To the Pacific and Back	U.S. map	Point to the locations mentioned in the read-aloud.
<b>Discussing the Read-Aloud (15 minutes)</b>		
Comprehension Questions	Tasks Checklist	Use this to answer Questions #4, 5, 6, and 8.
Word Work: Contentment	Image 11A-4	Have students discuss what they might say or do to show contentment.
 <b>Complete Remainder of the Lesson Later in the Day</b>		
<b>Extensions (20 minutes)</b>		
Tracking Lewis and Clark and the Corps of Discovery	Frontier Explorers Map; red crayon or marker; U.S. map	
Explorer’s Journal #8	Instructional Master 11B-1; writing and drawing tools	
Song: America, the Beautiful	U.S. map; Instructional Master 11B-2; audio recording of the song, “America, the Beautiful”	

### **Advance Preparation**

For *Vocabulary Preview*, find pictures of canyons (e.g., the Grand Canyon) to show students.

Make a copy of Instructional Master 11B-1 for each student. This will be the eighth and final page of their *Explorer's Journal*. Students will write about their favorite part of the expedition in their journals.

Find an audio recording of the song “America, the Beautiful” to play for the class. Make a copy of Instructional Master 11B-2 for students to follow and sing along.



# To the Pacific and Back

# 11A

**Note:** Introducing the Read-Aloud may have activity options that exceed the time allocated for this part of the lesson. To remain within the time periods allocated for this portion of the lesson, you will need to make conscious choices about which activities to include based on the needs of your students.

## ***Introducing the Read-Aloud***

**10** minutes

### **Where Are We?**

**5** minutes

Have students locate the Atlantic Ocean, the Appalachian Mountains, the Mississippi River, the Rocky Mountains, the Louisiana Purchase, the Missouri River, and the Pacific Ocean on a map.

### **What Have We Already Learned?**

**5** minutes

Review with students the three tasks that President Jefferson asked Lewis and Clark to accomplish on their expedition. You may wish to use Image Cards 11–13 when you talk about each task. Discuss with students which of the tasks Lewis and Clark were able to accomplish and which task they were unable to accomplish.

### **Vocabulary Preview**

**5** minutes

#### ***Canyons***



#### ← **Show image 11A-1: Advice from the Nez Perce**

1. In today's read-aloud the Nez Perce (nez pers) warn Lewis and Clark about the dangers of riding their canoes on the river through the *canyons*.
2. Say the word *canyons* with me three times.
3. Canyons are long, narrow valleys with steep sides.  
[Point out the steep sides of the canyons on the image.]



4. A river runs through the canyons.
5. [Show additional pictures of canyons.] Have you ever seen a canyon in real life before? How would you describe the canyon in this picture?

### **Purpose for Listening**

---

Explain to students that today they will hear about the last portion of Lewis and Clark's trip. Tell students to listen to find out whether or not Lewis and Clark made it to the Pacific Ocean and if everyone made it back to St. Louis.



## To the Pacific and Back

### ← Show image 11A-1: Advice from the Nez Perce

The closer Meriwether Lewis, William Clark, Sacagawea, and their friends came to the Pacific, the more Native American people they met. This land was home to many Native Americans who had lived there in settled **communities** for a long, long time.<sup>1</sup>

With the help of the Shoshones (shoh-SHOH-nee) and the Nez Perce (nez pers), the Corps of Discovery crossed the Rocky Mountains which stood between them and the Pacific Ocean. A new, powerful river began in these mountains. The captains hoped to ride it downhill to the ocean. But the Nez Perce warned, “In some places, this river rushes through narrow rock **canyons**, moving so quickly and powerfully that it is difficult to control a boat there.<sup>2</sup> You could be hurt if your boat hits the canyon walls or the sharp rocks sticking out of the water.”

1 Communities are groups of people who live together in the same place.

2 Canyons are steep valleys.



### ← Show image 11A-2: The assessment

William Clark and the group’s best canoeist climbed the rocks to look down at this part of the river.<sup>3</sup> They heard the roar of the water charging through the narrow canyon even before they saw it. Walking atop the rock rim high above, Clark asked the canoeist, “What do you think?”

“Captain,” the canoeist answered, “I expect to play my violin at our next campsite downriver, after we all get safely through this canyon.”<sup>4</sup>

Clark grinned. “That’s what I wanted to hear. Let us find the others.”

3 A canoeist is someone who paddles a canoe.

4 This means the canoeist thinks they can make it through the canyon.



### ← Show image 11A-3: Braving the rapids

The men pushed off from the shore, and the pirogues and canoes plunged into the rapids. The mighty **current**<sup>5</sup> pushed and pulled the boats, but working together, the men **steered**<sup>6</sup> around

5 or strong flow of water

6 or guided the boats

rocks and away from the canyon walls, keeping their balance whenever they thought their boats were going to tip over. Finally they came out the other end of the rocky canyon and into calm water. John Shields turned to his young friend, George Shannon. “What do you think, George?”

Shannon answered, “I was just starting to enjoy myself. Do you think they have any more of those around here?” Then both men laughed.

Soon afterward, the men landed on an island in the middle of the river just short of—or very close to—the place where the river emptied into the ocean. There, with the help of neighboring Native Americans, they survived another long, cold, rainy winter. At last the weather cleared, and they were able to travel the rest of the way to the Pacific Ocean.



← **Show image 11A-4: Seeing the Pacific Ocean**

There before them was the sight they had dreamed of seeing: the Pacific Ocean. Some of the men cheered. Others stood in silent **contentment**.<sup>7</sup>

Sacagawea was amazed. She had never seen an ocean, or even a picture of one. Clark heard that a whale had washed up on a nearby beach and took Sacagawea to see it. She told him, “I have traveled a long way with you to see the great waters, and now I have seen this monstrous whale as well. I am so happy to see the ocean!” Then she walked along the sand, happily letting the waves wash over her feet.

7 This means that they stood happily and quietly, looking at the Pacific Ocean.



← **Show image 11A-5: Returning home**

On March 23, 1806, nearly two years after first leaving St. Louis, the Corps of Discovery turned to head for home. They had mapped a great deal of the Louisiana Territory and beyond, from the Mississippi River to the Pacific.<sup>8</sup> They now knew how to get to the Pacific: they could take the Missouri River to the Rockies, cross the Rockies on foot, and then take other rivers to the Pacific Ocean. They had made friends with many Native Americans. They

8 This means that they had been able to draw maps of the areas across which they had traveled.

found out that no single river ran all the way from the Mississippi to the Pacific. They had learned about many animals, birds, fish, and insects.

They had more adventures on the journey home, of course, but in the end, everyone got back safely except for a few who chose not to go back.



← **Show image 11A-6: John Colter in the Mandan village**

John Colter, the man from whom the Teton Sioux had taken a horse, told Meriwether Lewis, “Captain, I have had enough of cities and crowds. I will stay in the west, if you will let me.” So Colter went to live among the Mandan people, promising, “I’ll be here when you come back,” and more than one of his friends did go back later to visit him.



← **Show image 11A-7: Saying goodbye to Charbonneau and Sacagawea**

Sacagawea and her husband, Toussaint Charbonneau, with their little son that everyone called “Pompey,” went home to the Shoshone. Lewis and Clark told Sacagawea, “If it were not for you, we would never have succeeded.” Sacagawea replied, “You showed me the great waters. We are friends. We helped each other.” Setting off again, Lewis and Clark watched Sacagawea, with her son in her arms, waving from the shore until a bend in the river blocked them from sight.



← **Show image 11A-8: Welcome home**

Months later, the travelers reached St. Louis. There they said their goodbyes and went their various ways, some to more adventures and some to quieter lives. Perhaps you would like to know what happened to the four people who had been most responsible for the journey.<sup>9</sup>

Meriwether Lewis became governor of the entire Louisiana Territory. William Clark became the governor of Missouri, then spent much of the rest of his life working with Native Americans on behalf of the government’s newly created Bureau of Indian Affairs.

9 [Point to the image of each person, from right to left, as the read-aloud refers to them.]

Thomas Jefferson continued as president until 1809. Eight years later, James Monroe, who had arranged for Jefferson to buy the Louisiana Territory, was himself elected President of the United States.

## ***Discussing the Read-Aloud***

**15** minutes

### **Comprehension Questions**

**10** minutes

1. *Literal* Did Lewis and Clark reach the Pacific Ocean? (Yes.)
2. *Literal* Did everyone in the read-aloud make it back home safely? (Yes, everyone made it home safely, except those who chose to stay and live in the Louisiana Territory.)
3. *Inferential* Why did Jefferson send Lewis and Clark to explore the Louisiana Territory? (No one in the United States knew what the Louisiana Territory was like.)
4. *Literal* What were the three tasks Jefferson asked Lewis and Clark to complete? (The three tasks were to make friends with Native Americans, record new plants and animals, and find an all-water route to the Pacific Ocean.)
5. *Literal* Were Lewis and Clark able to accomplish all three tasks? (No.)
6. *Literal* Which of the tasks were they able to accomplish? (Lewis and Clark made friends with the Native Americans and recorded new plants and animals.) Which of the tasks were they not able to accomplish? (Lewis and Clark did not find an all-water route to the Pacific Ocean. They had to go on foot through the Rockies and then sail other rivers to get to the Pacific Ocean.)
7. *Evaluative* Do you think Lewis and Clark's expedition was a success or not? Why? (Answers may vary.)

[Please continue to model the *Think Pair Share* process for students, as necessary, and scaffold students in their use of the process.]

I am going to ask a question. I will give you a minute to think about the question, and then I will ask you to turn to your neighbor and discuss the question. Finally, I will call on several of you to share what you discussed with your partner.

8. *Evaluative Think Pair Share:* Which one of the tasks do you think was the most important? Why? (Answers may vary.)
9. After hearing today’s read-aloud and questions and answers, do you have any remaining questions? [If time permits, you may wish to allow for individual, group, or class research of the text and/or other resources to answer these questions.]



### Word Work: Contentment

5 minutes

#### ← Show image 11A-4: Seeing the Pacific Ocean

1. In the read-aloud you heard, “[When the explorers finally saw the Pacific Ocean,] some of the men cheered. Others stood in silent *contentment*.”
2. Say the word *contentment* with me.
3. When someone is feeling contentment, they are feeling happy and satisfied.
4. The explorers felt contentment after their successful expedition.  
Shira felt contentment when she finished the painting she had been working on for weeks.
5. Think of a time when you felt contentment, or a time you felt happy and satisfied.  
[Ask two or three students. If necessary, guide and/or rephrase the students’ responses: “I felt contentment when . . . ”]
6. What’s the word we’ve been talking about?

Use a *Word to World* activity for follow-up. Directions: Discuss with your partner some things you would say and some things you would do to show contentment.

[Have students use the image for reference.]



**Complete Remainder of the Lesson Later in the Day**



# To the Pacific and Back

**11<sub>B</sub>**

**Note:** Extensions may have activity options that exceed the time allocated for this part of the lesson. To remain within the time periods allocated for this portion of the lesson, you will need to make conscious choices about which activities to include based on the needs of your students.

## ***Extensions***

**20** *minutes*

### **Tracking Lewis and Clark and the Corps of Discovery**

**10** *minutes*

- Have students point to the place where Lewis and Clark and the Corps of Discovery started their journey. (St. Louis)
- Then have students follow the red X's along the Missouri river until they reach the Rocky Mountains. Ask students: "Could Lewis and Clark travel through the Rocky Mountains by river?" (no)  
"How did they cross the Rocky Mountains?" (by walking)
- Now, have students follow Lewis and Clark's route up to the fifth and final dot. Have students draw red X's up to the fifth dot. Ask, "Where did the expedition end?" (Pacific Ocean)
- Remind students that they found out how to get to the Pacific Ocean—take the Missouri River to the Rocky Mountains, cross the Rockies on foot, and then take other rivers to the Pacific Ocean.
- Tell students that after reaching the Pacific Ocean, most of them headed back to St. Louis. Have students retrace their route back to St. Louis.

### **Explorer's Journal #8 (Instructional Master 11B-1)**

**15** *minutes*

- Remind students that Lewis and Clark recorded all of their discoveries and events in a journal. Tell students they will make the last entry in their journals.

- Have students pretend they are one of the members of the Corps of Discovery traveling with Lewis and Clark. They will record their favorite part of the expedition.
  - First, have them think about everything they heard about Lewis and Clark’s travels over the past few days. [You may wish to show various Flip Book images to refresh their memory of events that happened.]
  - Next, have students choose their favorite part of the expedition to draw and to write about in their journals.
  - Then, have them draw a picture of their favorite part and write several sentences about their favorite part of the expedition.
  - Finally, have students share their drawings and writing with their partner or home-language peers.

**Song: America, the Beautiful  
(Instructional Master 11B-2)**

**10** *minutes*

- Remind students that Lewis and Clark and the Corps of Discovery explored the Louisiana Territory and beyond. The information from their journals and maps helped President Jefferson learn more about this area of the United States.
- Have students point to the eastern (Atlantic) coast of the United States. Remind them that America started out along the eastern (Atlantic) coast. Ask: “Now how big is America?” (point to the western (Pacific) coast)
- Tell students that many years after Lewis and Clark’s expedition, someone wrote a poem about America, and someone else composed music for the poem.
- Say the words of the song with students. After students are familiar with the words of the song, invite them to sing along with an audio recording of the song.



## **America, the Beautiful**

Written by Catherine Lee Bates

Composed by Samuel A. Ward

*O beautiful for spacious skies,  
For amber waves of grain,  
For purple mountain majesties  
Above the fruited plain!*

*America! America!  
God shed His grace on thee,  
And crown thy good with brotherhood  
From sea to shining sea!*

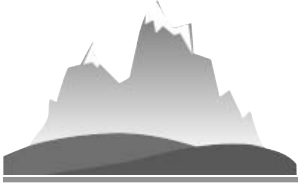

# Domain Review



## ***Note to Teacher***

---

You should spend one day reviewing, reinforcing, or extending the material taught in this domain. You may have students do any combination of the activities provided, in either whole-group or small-group settings.

## ***Core Content Objectives Addressed in This Domain***

---

Students will:

- ✓ Recall basic facts about Daniel Boone
- ✓ Describe Daniel Boone as a trailblazer
- ✓ Identify what the Wilderness Road refers to
- ✓ Locate the Appalachian Mountains on a map
- ✓ Locate the Mississippi River on a map
- ✓ Locate the Rocky Mountains on a map
- ✓ Explain why Jefferson wanted to purchase New Orleans
- ✓ Identify and locate the Louisiana Territory on a map
- ✓ Explain the significance of the Louisiana Territory and Purchase
- ✓ Explain the reasons that Lewis and Clark went on their expedition
- ✓ Explain that there were many, many Native American tribes already living in the Louisiana territory before the Lewis and Clark expedition
- ✓ Recall basic facts about Lewis and Clark's encounters with Native Americans
- ✓ Explain why and how Sacagawea helped Lewis and Clark

# Review Activities

---

## Image Review

---

You may show the Flip Book images from any read-aloud again and have students retell the read-aloud using the images.

## Image Card Review

---

### Materials: Image Cards 8–22

Hold Image Cards 8–22 in your hand, fanned out like a deck of cards. Ask a student to choose a card but not show it to anyone else in the class. The student must then perform an action or say a clue about the picture s/he is holding. For example, for one of the tasks Lewis and Clark were to accomplish, a student may say, “This is one of the tasks that Lewis and Clark were supposed to accomplish.” The rest of the class will guess what person or object is being described. Proceed to another card when the correct answer has been given.

(You may also wish to include Image Cards 5 and 7, related to the content about Daniel Boone from the first two lessons, as a refresher prior to the Domain Assessment.)

## Timeline Review

---

### Materials: Timeline; Image Cards 1–5 and 7–10

Review the images on the timeline. You may wish to shuffle the nine Image Cards and invite students to arrange them in chronological order onto the timeline.

## You Were There: Corps of Discovery

---

Have students pretend that they were one of the people in the Corps of Discovery. Ask students to describe who they are and what they did.

## Riddles for Core Content

---

Ask students riddles such as the following to review core content:

- I am Shoshone and was a guide and translator for Lewis, Clark, and the Corps of Discovery. Who am I? (Sacagawea)
- I am a piece of land or territory that President Jefferson bought from France that doubled the size of the United States. What am I called? (Louisiana Territory)
- We were hired by Thomas Jefferson to explore the Louisiana Territory? Who are we? (Lewis and Clark and the Corps of Discovery)

## Using a Map

---

**Materials:** *Frontier Explorers Map*; U.S. map

Use a map of the United States to review various locations from the read-alouds. Ask questions such as the following:

- Daniel Boone was one of the settlers who wanted to move west. Which mountain range was a barrier to moving west?
- Lewis and Clark led the expedition to explore the Louisiana Territory. From which city did they begin their expedition?
- Most of Lewis and Clark's journey was by boat. On which river did Lewis and Clark travel?
- Lewis and Clark had to travel by foot for part of their journey. Which mountain range did they have to walk over?

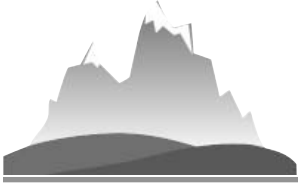

# Domain Assessment

# DA

This domain assessment evaluates each student's retention of the domain and academic vocabulary words and the core content targeted in *Frontier Explorers*. The results should guide review and remediation the following day.

There are three parts to this assessment. You may choose to do the parts in more than one sitting if you feel this is more appropriate for your students. Part I (vocabulary assessment) is divided into two sections: the first assesses domain-related vocabulary and the second assesses academic vocabulary. Parts II and III of the assessment address the core content targeted in *Frontier Explorers*.

## 10 Part I (Instructional Master DA-1)

Directions: I am going to say a sentence using a word you have heard in the read-alouds and the domain. First I will say the word, and then I will use it in a sentence. If I use the word correctly in my sentence, circle the smiling face. If I do not use the word correctly in my sentence, circle the frowning face. I will say each sentence two times. Let's do number one together.

1. **Frontier:** The frontier is a place where many people have been and where many people live. (frowning face)
2. **Pioneers:** Pioneers are people who are excited to go to new places and try new things. (smiling face)
3. **Trailblazer:** Daniel Boone is known as a trailblazer who helped to widen the Native American trails through the mountains. (smiling face)
4. **Emperor:** An emperor works for a king and does not have much power. (frowning face)
5. **Louisiana Territory:** The Louisiana Territory stretched from the Mississippi River to the Rocky Mountains. (smiling face)

6. **Expedition:** An expedition is a short, easy journey that people take for fun. (frowning face)
7. **Canyons:** Canyons are little rocks that stick out from the ground. (frowning face)
8. **Prairie:** A prairie is a large and flat land covered with grass. (smiling face)
9. **Translate:** When people translate, they change words from one language into another language so that everyone can understand each other. (smiling face)
10. **Journal:** Lewis and Clark wrote about the new plants and animals they discovered in a journal. (smiling face)

Directions: Now I am going to read more sentences using other words you have heard and practiced. First I will say the word, and then I will use it in a sentence. If I use the word correctly in my sentence, circle the smiling face. If I do not use the word correctly in my sentence, circle the frowning face. I will say each sentence two times.

11. **Barrier:** A barrier is something that separates or blocks you from going from one place to another place. (smiling face)
12. **Loyal:** A loyal friend will tell you lies. (frowning face)
13. **Purchase:** When you purchase something you buy it. (smiling face)
14. **Double:** *Double* means two times as much. (smiling face)
15. **Task:** A task is a job or work that needs to be done. (smiling face)

## 10 Part II (Instructional Master DA-2)

Directions: In each row there are four pictures: Daniel Boone, Thomas Jefferson, Lewis and Clark, and Sacagawea. Listen to my sentences about these people, who helped to expand and explore the United States a long time ago. After I read a sentence, circle the picture of the person or people my sentence is about. I will read each sentence two times.

1. I found a way to cross the Appalachian Mountains by using a Native American footpath. (Daniel Boone)

2. I was the third president of the United States. (Thomas Jefferson)
3. I helped to blaze the Wilderness Road and opened up the way for other settlers to move west. (Daniel Boone)
4. I purchased the Louisiana Territory from Napoleon. (Thomas Jefferson)
5. We led the Corps of Discovery in an expedition of the Louisiana Territory and beyond. (Lewis and Clark)
6. I was a guide and translator for the Corps of Discovery. (Sacagawea)
7. The tribe I am from lived in the west for a long time before the Louisiana Purchase. (Sacagawea)
8. We recorded information about many new plants and animals in our journals. (Lewis and Clark)
9. My brother was the Shoshone chief who helped Lewis and Clark cross the Rocky Mountains. (Sacagawea)
10. After almost two years of exploring, we reached the Pacific Ocean. (Lewis and Clark)

### **10 Part III (Instructional Master DA-3)**

---

Directions: Look at your map.

1. First, find the Appalachian Mountains and color them brown.
2. Next, find the Mississippi River and color it blue.
3. Find the Missouri River and color it red.
4. Then, find the Rocky Mountains and color them yellow.
5. Last, find the area or territory that represents the Louisiana Purchase and color it green.



# Culminating Activities



## **Note to Teacher**

---

Please use this final day to address class results of the Domain Assessment. Based on the results of the Domain Assessment and students' Tens scores, you may wish to use this class time to provide remediation opportunities that target specific areas of weakness for individual students, small groups, or the whole class.

Alternatively, you may also choose to use this class time to extend or enrich students' experience with domain knowledge. A number of enrichment activities are provided below in order to provide students with opportunities to enliven their experiences with domain concepts.

## **Remediation**

---

You may choose to regroup students according to particular area of weakness, as indicated from Domain Assessment results and students' Tens scores.

Remediation opportunities include:

- targeting Review Activities
- revisiting lesson Extensions
- rereading and discussing select read-alouds

## **Enrichment**

---

### **Sacagawea and the Dollar Coin**

---

#### **Materials: Dollar Coins**

Bring in dollar coins and show students the picture of Sacagawea. The dollar coin was minted first in 2000 and commemorates her contribution to Lewis and Clark's expedition. Ask students why they think Sacagawea was chosen to be honored on a coin.



## Explorer’s Journal Cover Page

---

### **Materials: Instructional Master CA-1; writing tools**

Have students make a cover page for their journals. Tell students to complete the sentence: “This journal is about . . .”

## Domain-Related Trade Book or Student Choice

---

### **Materials: Trade book**

Read a trade book to review particular people, events, or concepts; refer to the books listed in the Introduction. You may also choose to have students select a read-aloud to be heard again.

## You Were There: Corps of Discovery

---

Have students pretend that they were one of the people in the Corps of Discovery. Ask students to describe who they are and what they did.

## On Stage: Lewis and Clark and the Corps of Discovery

---

**Note:** This activity may require additional instruction in the topics of timing and voice.

Have a group of students plan and then act out roles played by the important people discussed in this domain, e.g., Thomas Jefferson, James Monroe, Lewis, Clark, Sacagawea, etc.

## Letters to Lewis and Clark and Sacagawea

---

Have students choose people who were introduced in this domain and about whom they wish they knew more. Ask them to brainstorm a list of questions they would ask that person. Then, have them write letters using their lists of questions as starting points.

## Sign Language

---

Remind students that often the Native American tribes and Lewis and Clark used sign language to communicate since they didn’t know the same spoken language. In partners, have students try to communicate with each other without talking, using only signs

they can make with their hands, arms, facial expressions, etc. Discuss with students the difficulties this may have presented.

### **Class Book: Frontier Explorers**

---

#### **Materials: Drawing paper, drawing tools**

Tell the class or a group of students that they are going to make a class book to help them remember what they have learned in this domain. Have students brainstorm important information about Daniel Boone and Lewis and Clark. Have each student choose one idea to draw a picture of, and then write a caption for the picture. Bind the pages to make a book to put in the class library for students to read again and again.

**For Teacher Reference Only:**

Instructional Masters for  
*Frontier Explorers*

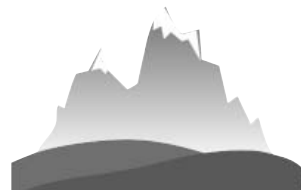



**Frontier Explorers Map**

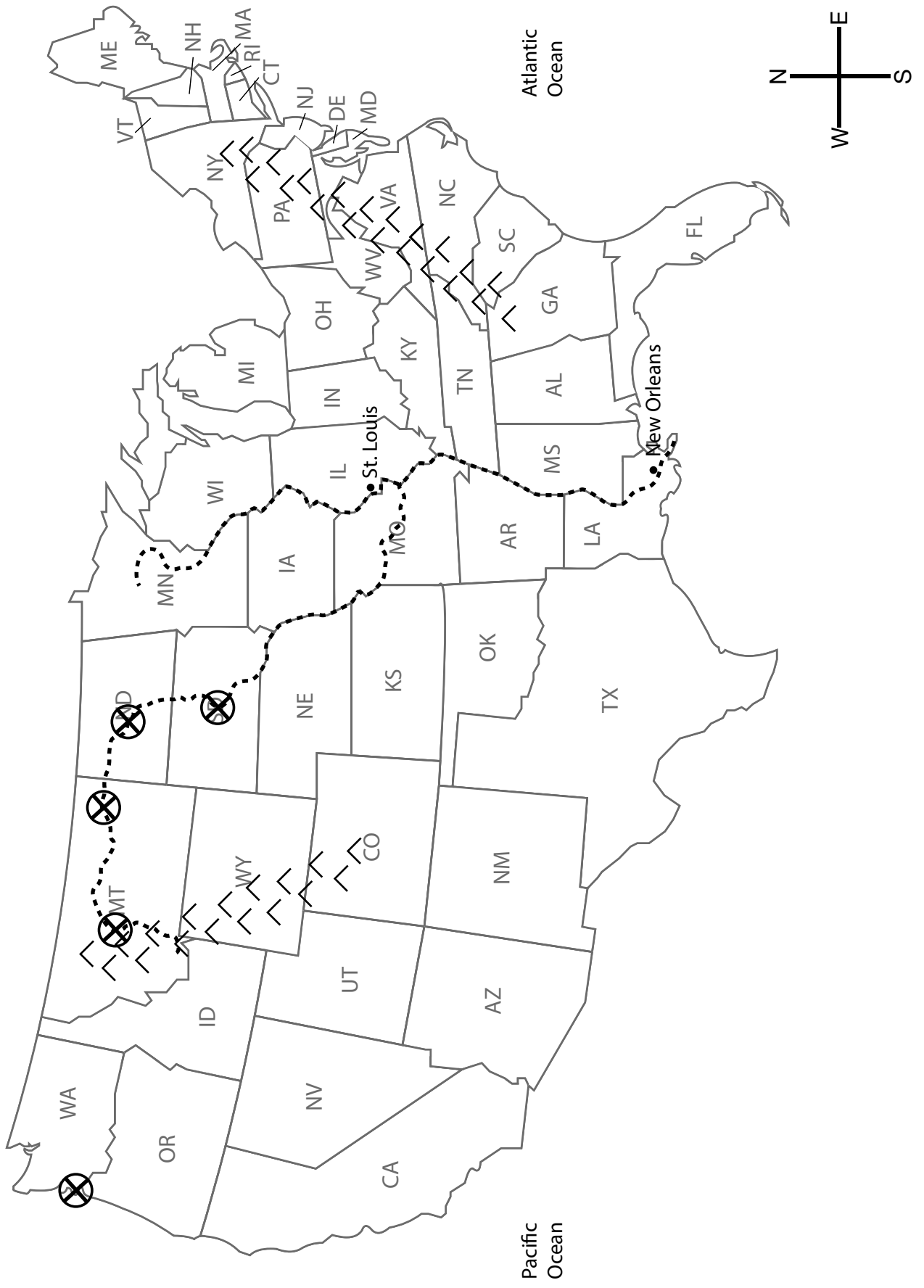



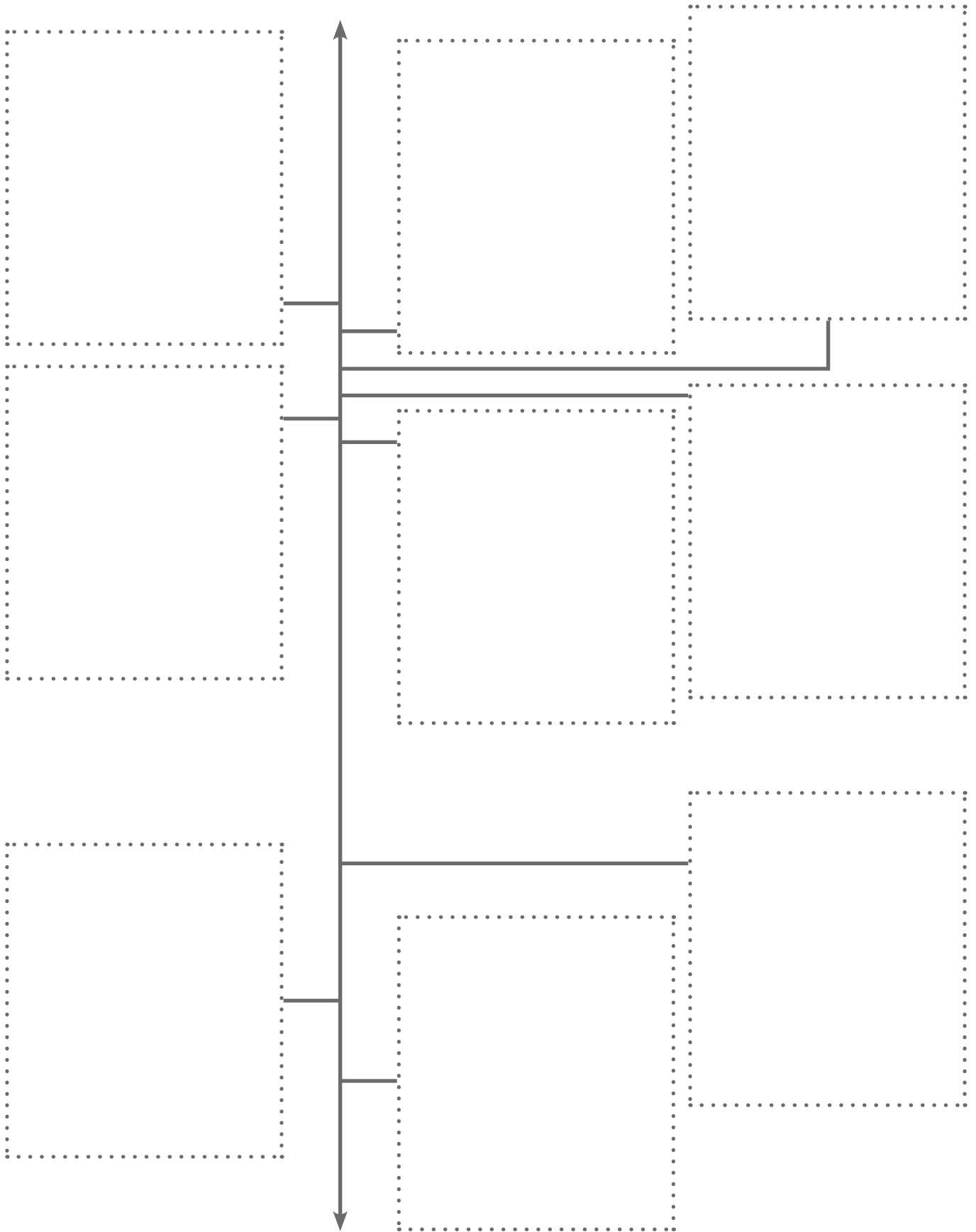

1

---

---

---

---

---

---

---

---

2

---

---

---

---

---

---

---

---

3

---

---

---

---

---

---

---

---



# Answer Key

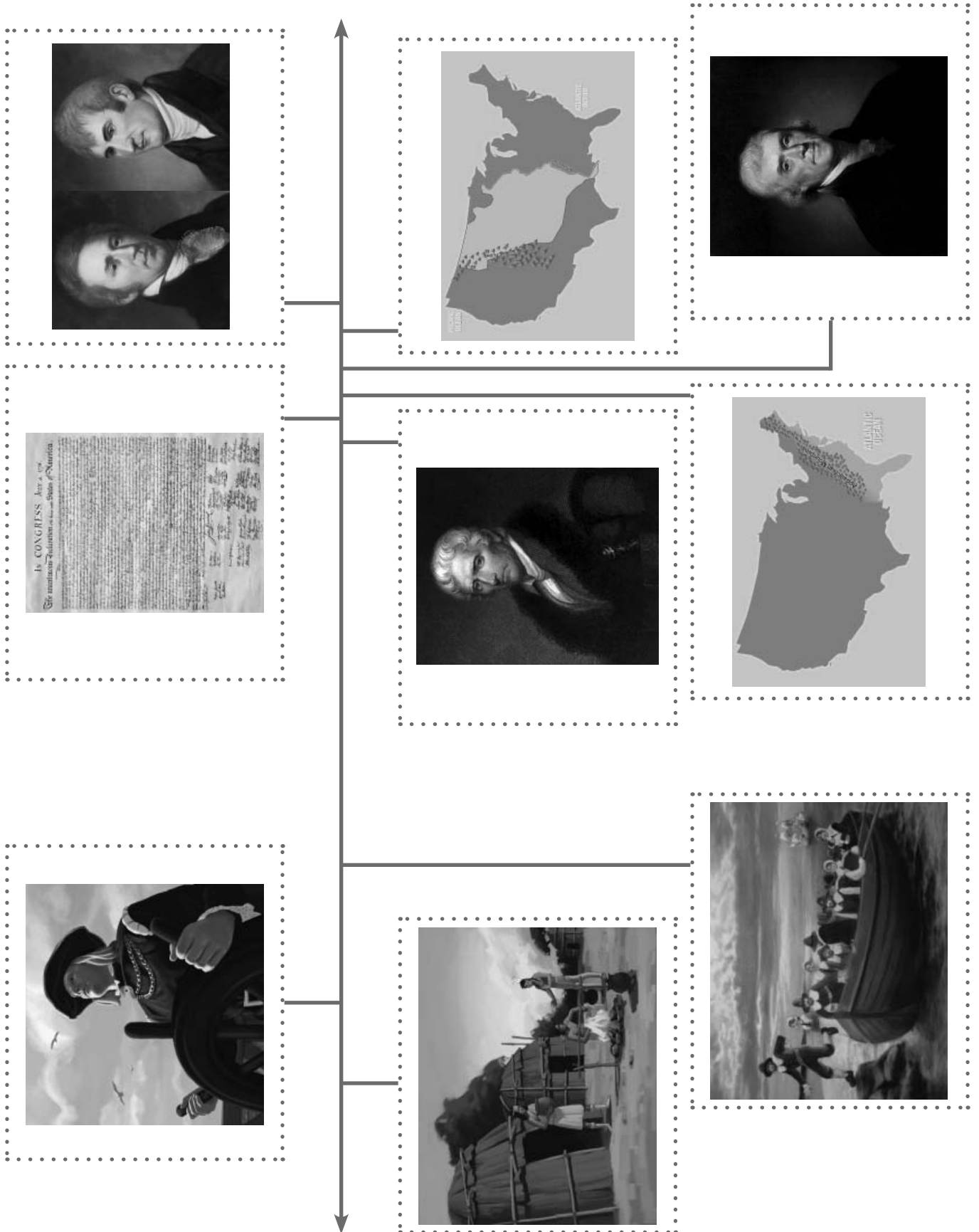









Handwriting practice lines consisting of three sets of solid top and bottom lines with a dashed midline.

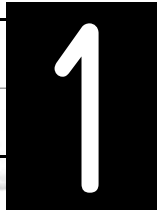

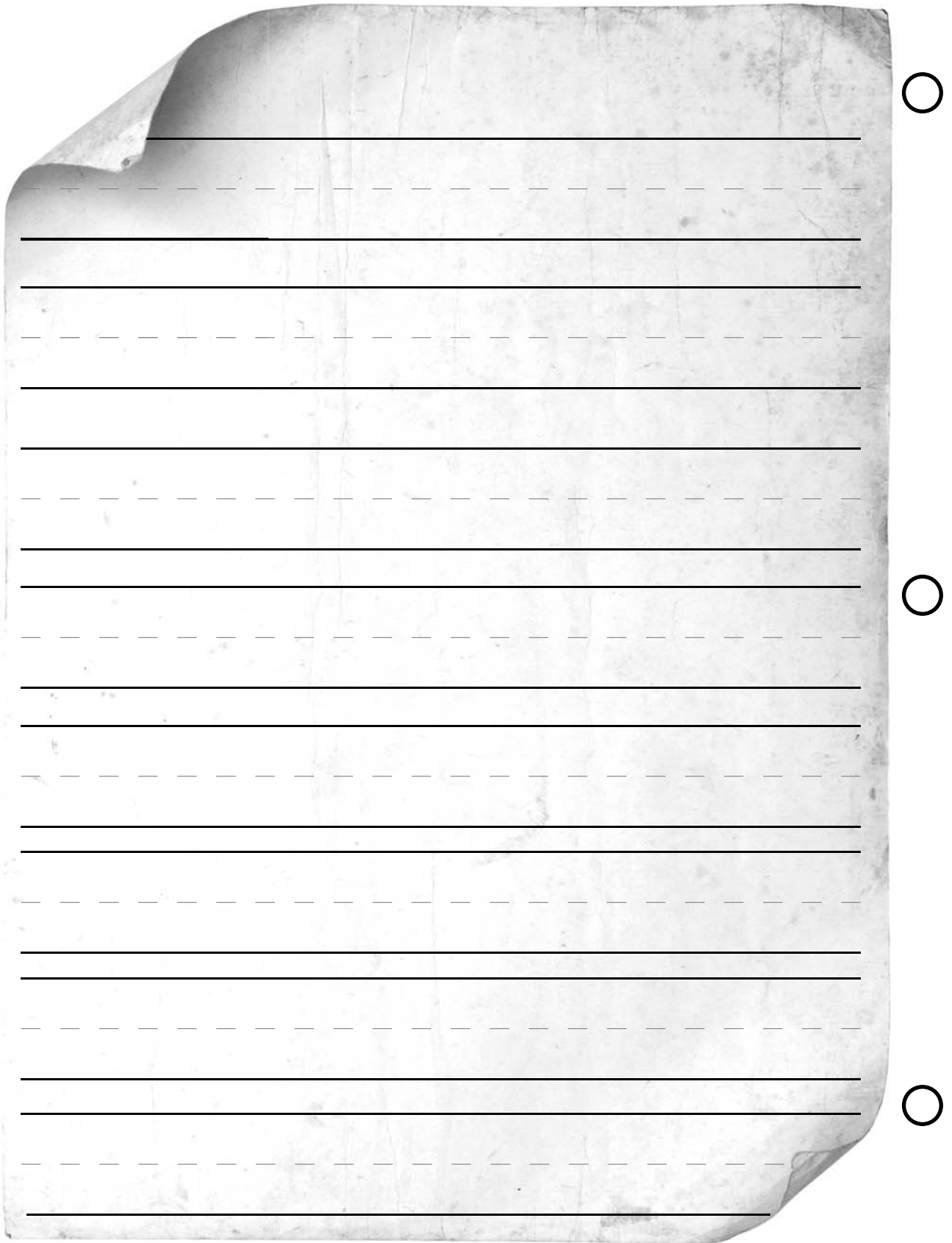



Dear Family Member,

Our class has begun the *Frontier Explorers* domain. During the next several days, your child will learn about the westward expansion of the United States. Your child will learn about Daniel Boone, one of the first European settlers to explore the land west of the Appalachian Mountains.

Below are some suggestions for activities you may do at home to reinforce what your child is learning about this period of westward expansion.

### 1. Where Are We?

Have your child locate the Appalachian Mountains on the map provided with this letter. Your child has learned that the United States began as the thirteen colonies along the eastern (Atlantic) coast. At that time, the Appalachian Mountains were a barrier to people who wanted to move west. Ask your child what Daniel Boone did to help. (Daniel Boone helped widen Native American trails through the mountains. The trails became known as the Wilderness Road, which allowed other settlers to move west.)

Save this map, and invite your child to tell you what s/he is learning about westward expansion by pointing out different locations on the map.

### 2. The Appalachian Mountains

Your child will hear about a mountain range called the Appalachian Mountains. Often simply called the Appalachians, this mountain range is located in eastern North America and was a barrier to east-west travel during the time of the thirteen English colonies. Have your child describe the Appalachian Mountains using the picture.



You may also wish to teach your child the first stanza of the song “On Top of Old Smoky.” “Old Smoky” refers to a part of the Appalachian Mountain range called the Old Smoky Mountains.

### **3. If You Were There**

With your child, imagine what it would have been like to have been with Daniel Boone when he crossed the Appalachian Mountains or when he helped to widen the Native American footpaths which became the Wilderness Road.

Also have your child consider how the Native Americans might have felt when the settlers began claiming the land that they had lived on for hundred of years and how they might have felt about being forced to move off their land.

### **4. Borrow a Book**

Set aside time to read to your child each day. The local library or your child's teacher may have books about this period of American history. A list of books is attached to this letter.

Be sure to let your child know how much you enjoy hearing about what s/he has been learning at school.



## ***Recommended Resources for Frontier Explorers***

---

### **Trade Book List**

---

1. *Bewildered for Three Days As to Why Daniel Boone Never Wore His Coonskin Cap*, by Andrew Glass (Holiday House, 2000) ISBN 978-0823414468
2. *Exploring the West*, edited by E. D. Hirsch, Jr. (Pearson Learning, 2002) ISBN 978-0769050119
3. *Ghost Town at Sundown (Magic Tree House, #10)*, by Mary Pope Osborne (Random House Books for Young Readers, 1997) ISBN 978-0679883395
4. *I Am: Sacagawea*, by Grace Norwich and illustrated by Anthony Vanarsdale (Scholastic Paperbacks, 2012) ISBN 978-0545405744
5. *The Legend of Daniel Boone*, by Eric Blair and illustrated by Micah Chambers-Goldberg (Picture Window Books, 2005) ISBN 978-1404809741
6. *Lewis and Clark*, by Lisa Wade McCormick (Scholastic Inc., 2006) ISBN 978-0516214436
7. *Lewis and Clark: A Prairie Dog for the President*, by Shirley Raye Redmond (Random House, 2003) ISBN 978-0375811203
8. *Lewis and Clark: Explorers of the American West*, by Steven Kroll (Holiday House, 1996) ISBN 978-0823412730
9. *Lewis and Clark for Kids: Their Journey of Discovery with 21 Activities*, by Janis Herbert (Chicago Review Press, 2000) ISBN 978-1556523748
10. *The Mississippi River*, by Allan Fowler (Children's Press, 2000) ISBN 978-0516265568
11. *A Picture Book of Davy Crockett*, by David A. Adler and illustrated by John and Alexandra Wallner (Holiday House, 1996) ISBN 978-0823412129

12. *A Picture Book of Sacagawea*, by David A. Adler and illustrated by Dan Brown (Holiday House, 2000)  
ISBN 978-0823414857
13. *Postcards from William*, by Betty Southard Stokes and illustrated by Emry Quinn (Harmony House Publishers, 2006)  
ISBN 978-1564692023
14. *Sacagawea*, by Jan Gleiter and Kathleen Thompson and illustrated by Yoshi Miyake (Raintree/Steck-Vaughn, 1998)  
ISBN 978-0817268893
15. *Seaman's Journal: On the Trail with Lewis and Clark*, by Patricia Reeder Eubank (Ideals Children's Books, 2002)  
ISBN 978-0824954420
16. *Who Was Daniel Boone?*, by Sydelle Kramer and illustrated by George Ulrich (Grosset and Dunlap, 2006)  
ISBN 978-0448439020







## Vocabulary List for Frontier Explorers (Part 1)

This list includes many important words your child will learn about in *Frontier Explorers*. Try to use these words with your child in English and in your native language. Next to this list are suggestions of fun ways your child can practice and use these words at home.

- barrier
- settlements
- woodsmen
- passes
- pioneers
- trailblazer
- wilderness
- emperor
- intelligent
- loyal
- brilliant
- clever
- mansion
- purchase
- territory

*Directions: Help your child pick a word from the vocabulary list. Then help your child choose an activity and do the activity with the word. Check off the box for the word. Try to practice a word a day in English and in your native language.*

	<b>Draw it</b>
	<b>Use it in a sentence</b>
	<b>Find one or two examples</b>
	<b>Tell a friend about it</b>
	<b>Act it out</b>
	<b>Make up a song using it</b>





**Frontier Explorers Map**

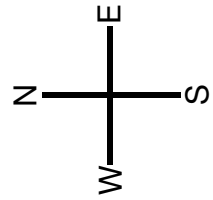
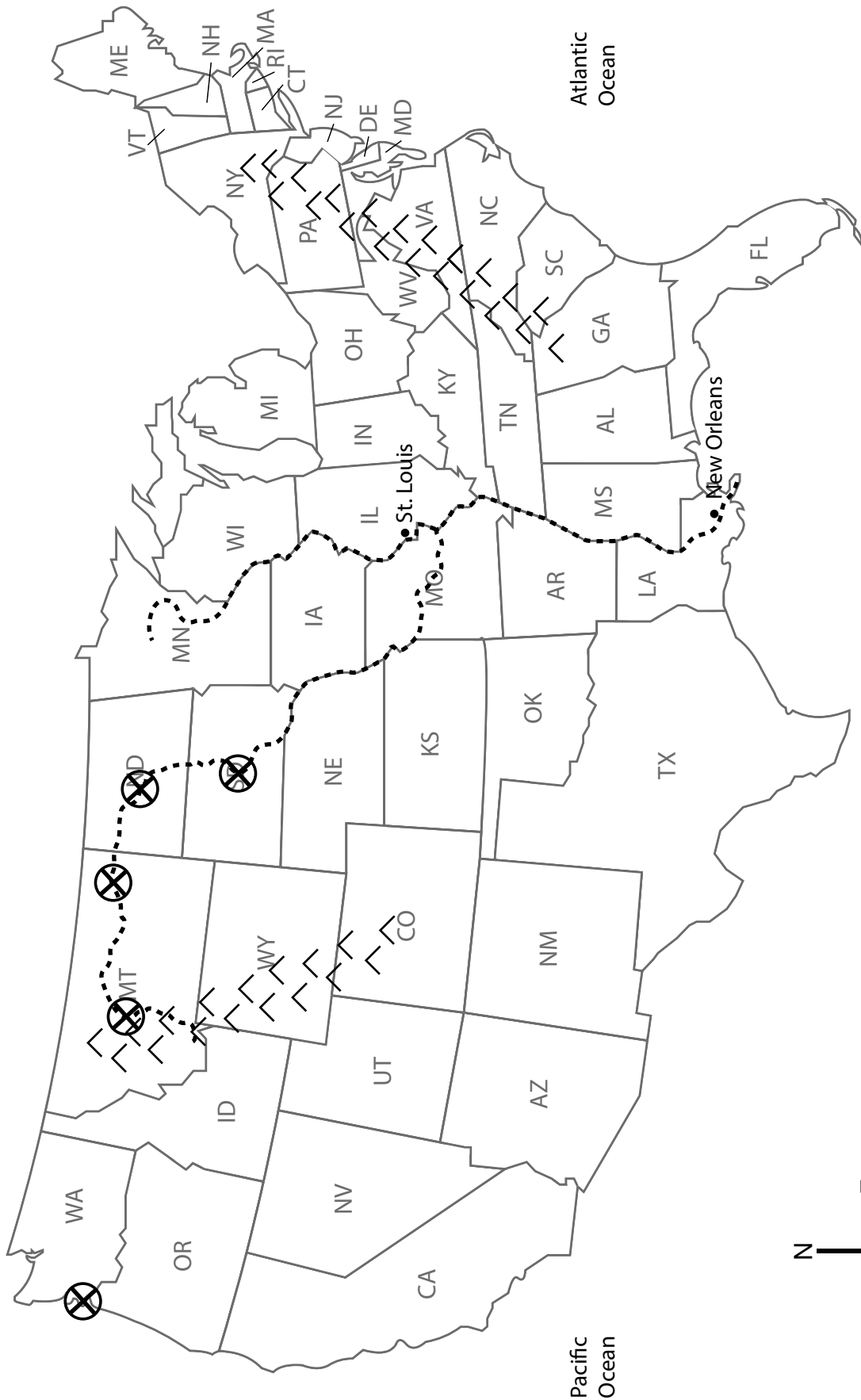



Name \_\_\_\_\_

\_\_\_\_\_  
\_\_\_\_\_  
\_\_\_\_\_

N

W

E

S





Somebody	
Wanted	
But	
So	
Then	



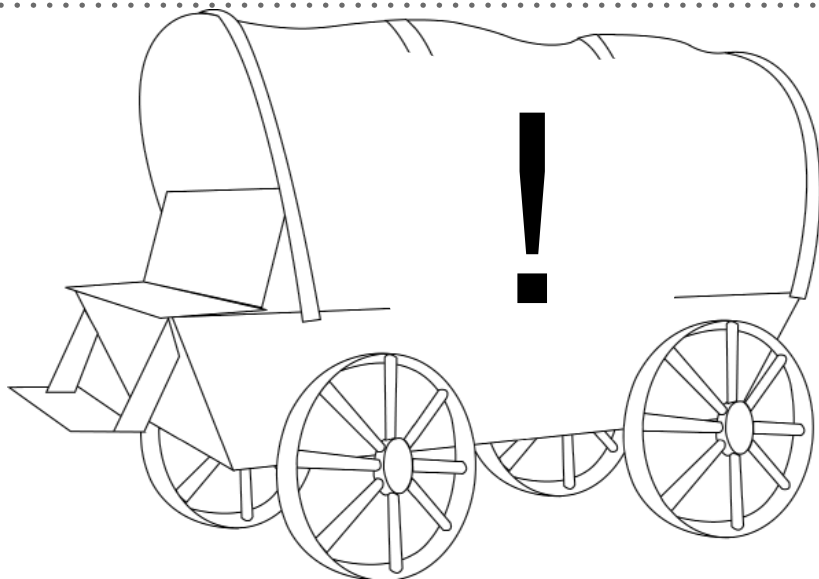
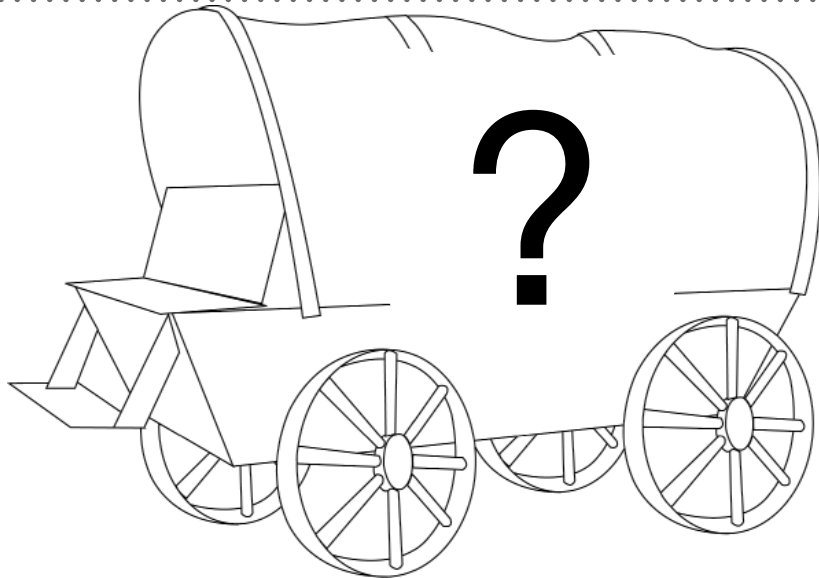
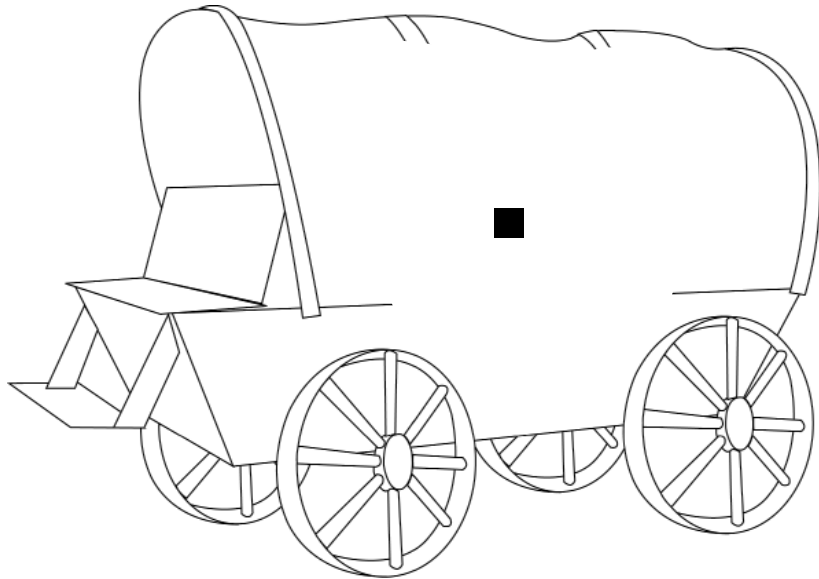



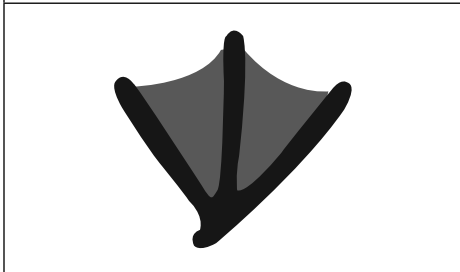
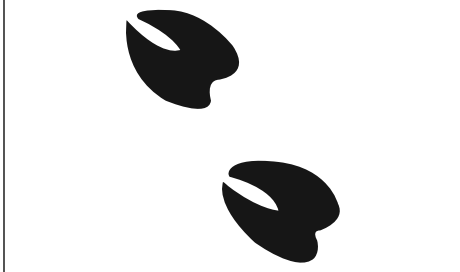
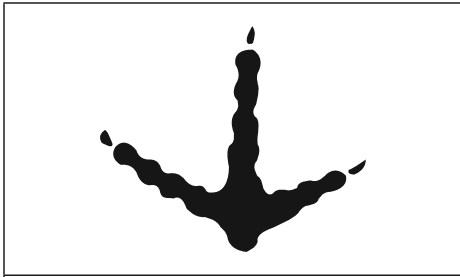

**deer**

**coyote**

**skunk**

**turkey**

**bear**

**duck**



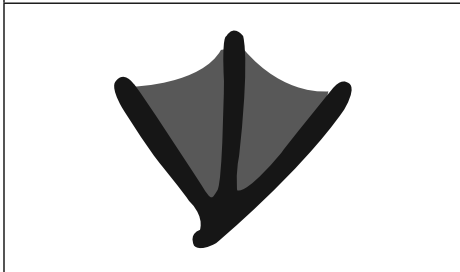
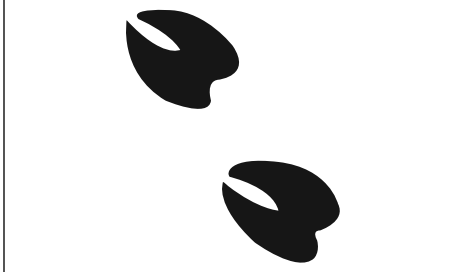
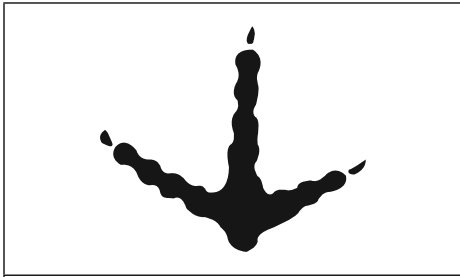

deer

coyote

skunk

turkey

bear

duck





Name \_\_\_\_\_

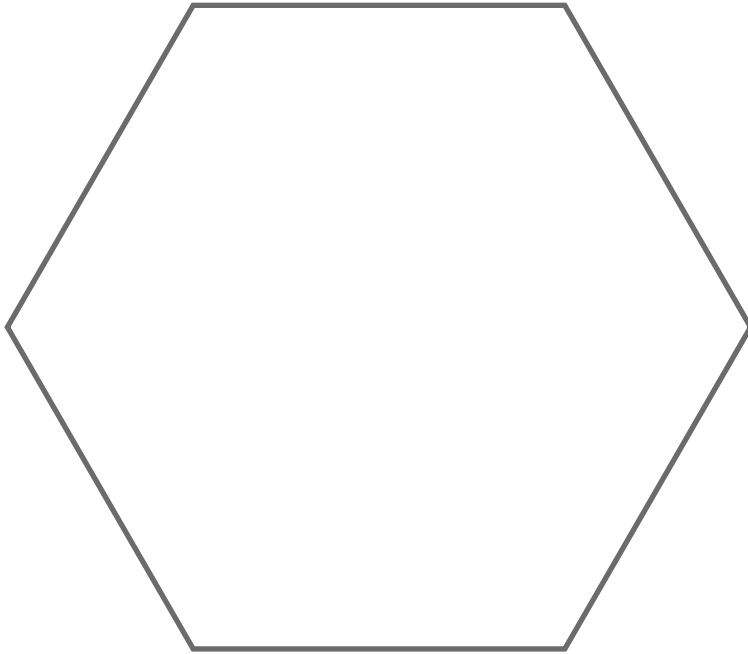

Four sets of horizontal writing lines, each consisting of a solid top line, a dashed middle line, and a solid bottom line, providing space for handwriting practice.





\_\_\_\_\_  
\_\_\_\_\_  
\_\_\_\_\_  
\_\_\_\_\_  
\_\_\_\_\_  
\_\_\_\_\_  
\_\_\_\_\_  
\_\_\_\_\_  
\_\_\_\_\_  
\_\_\_\_\_

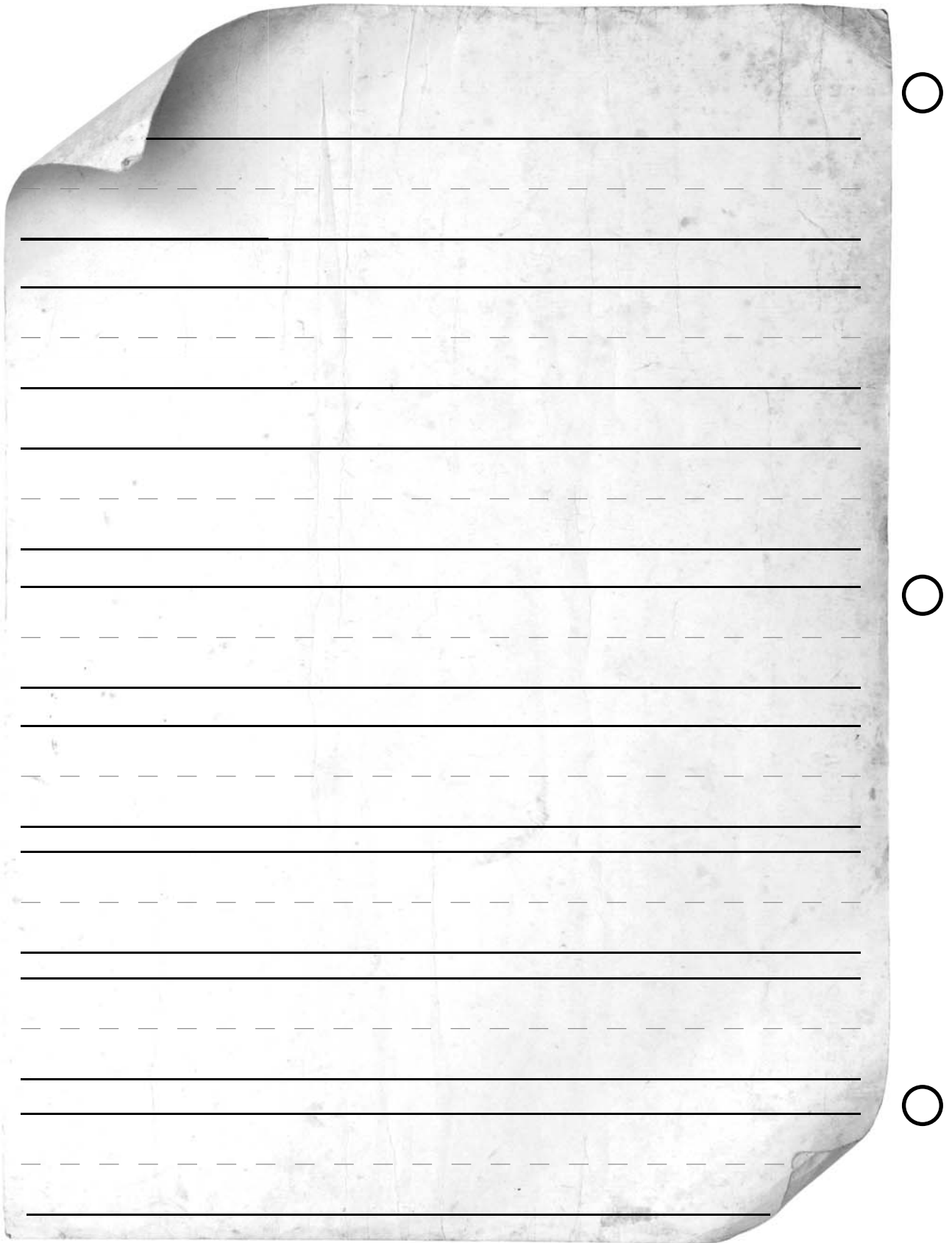

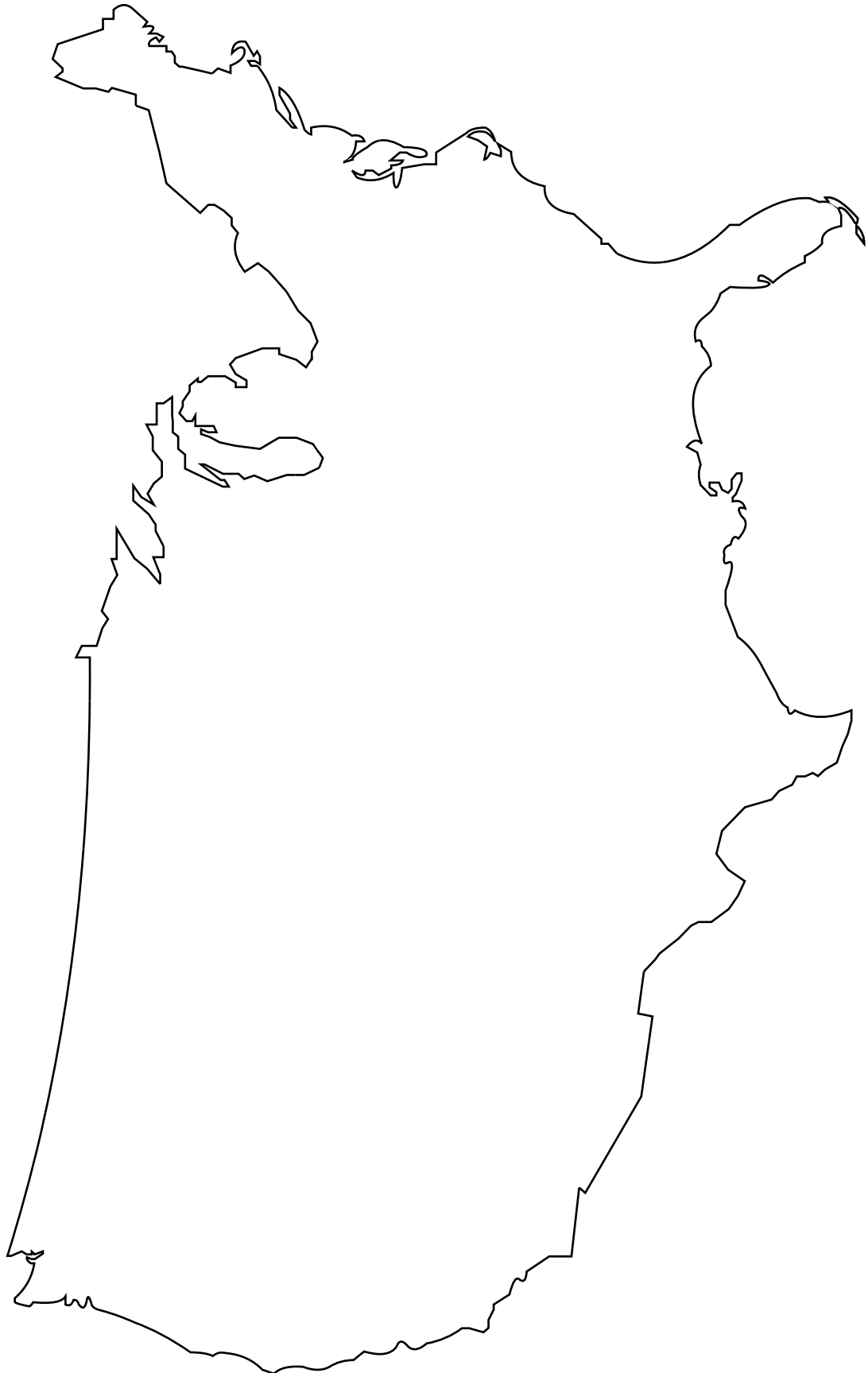



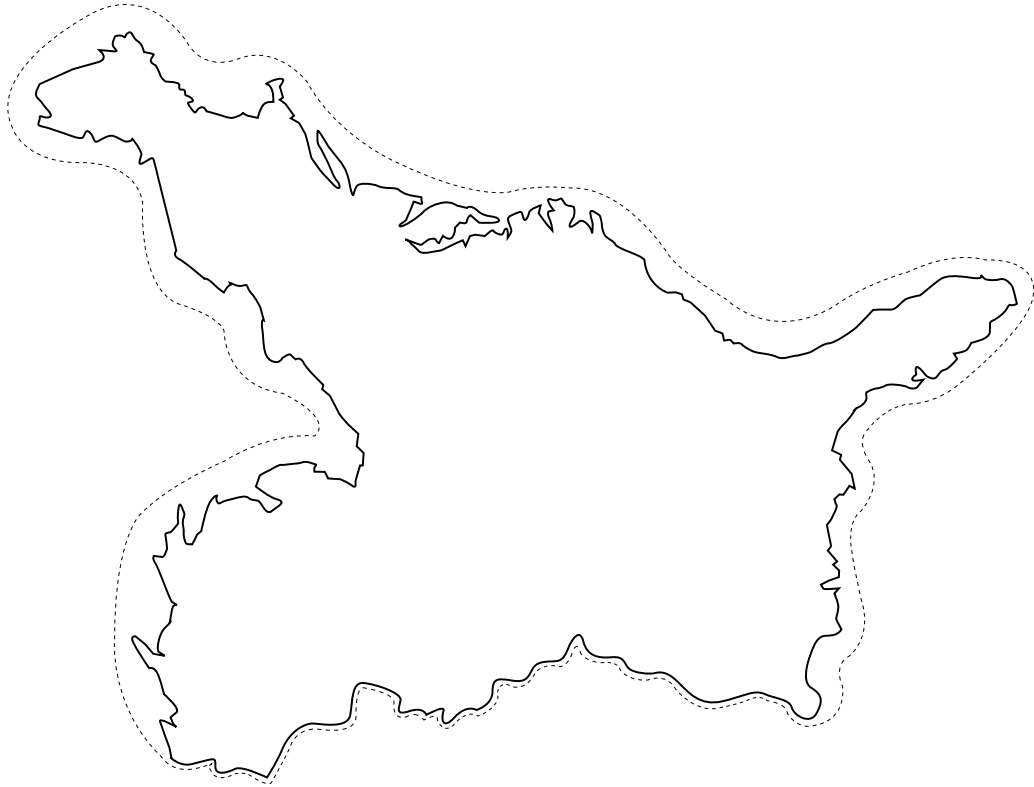





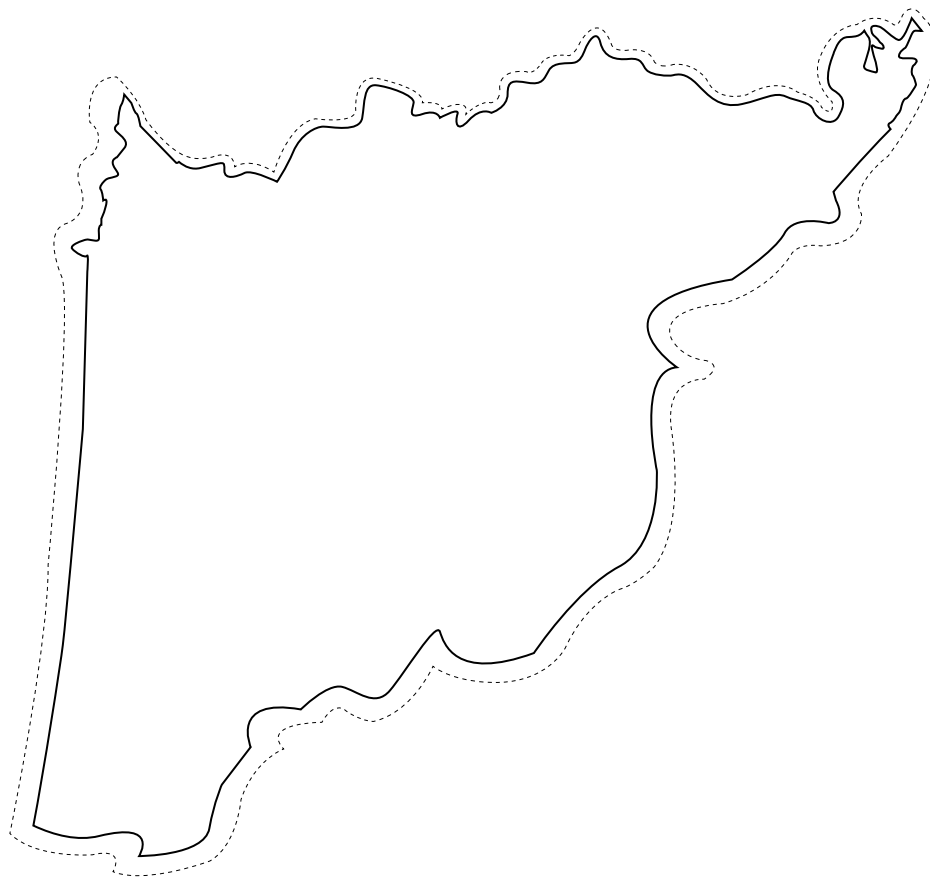





\_\_\_\_\_

-----

\_\_\_\_\_

-----

\_\_\_\_\_

-----



\_\_\_\_\_

-----

\_\_\_\_\_

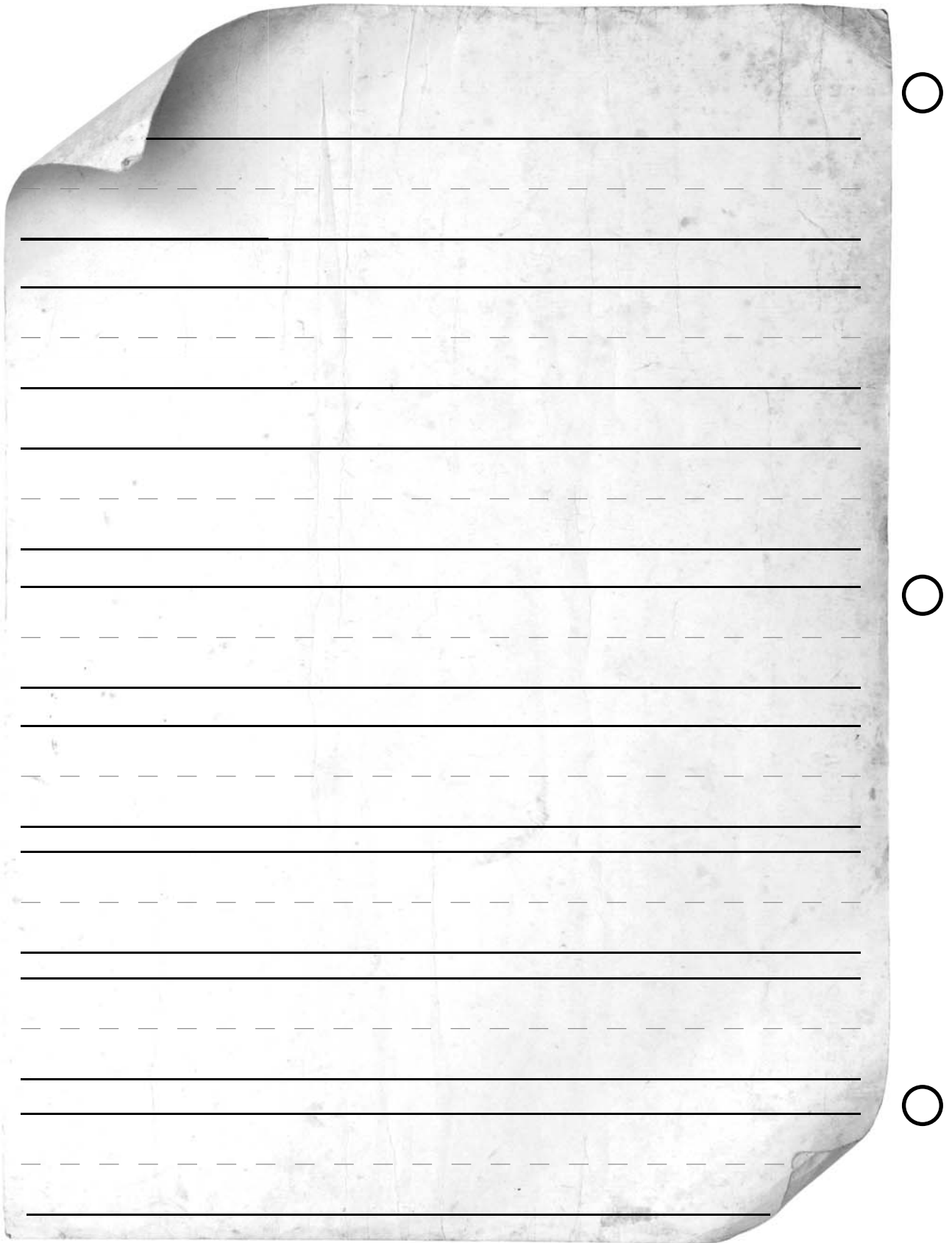

Directions: Find the Appalachian Mountains and color them brown. Find the Mississippi River and color it blue. Find the area that was the United States before the Louisiana Purchase and color it orange.

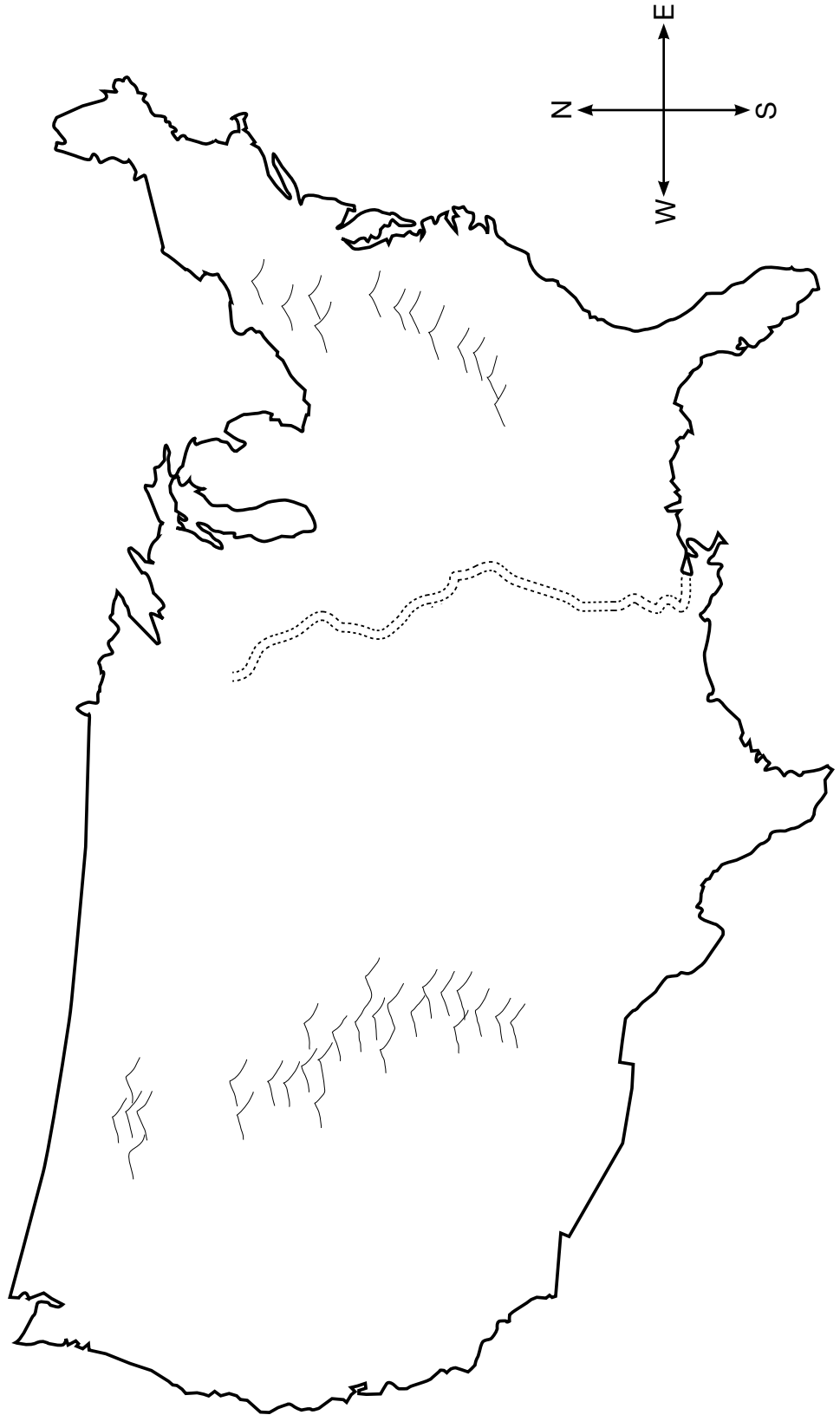



1. T F

2. T F

3. T F

4. T F

5. T F

6. T F

7. T F

8. T F

9. T F

10. T F





1.

T

F

2.

T

F

3.

T

F

4.

T

F

5.

T

F

6.

T

F

7.

T

F

8.

T

F

9.

T

F

10.

T

F



**Tasks Checklist**



**Tasks Checklist**







Handwriting practice lines consisting of solid top and bottom lines with a dashed midline.



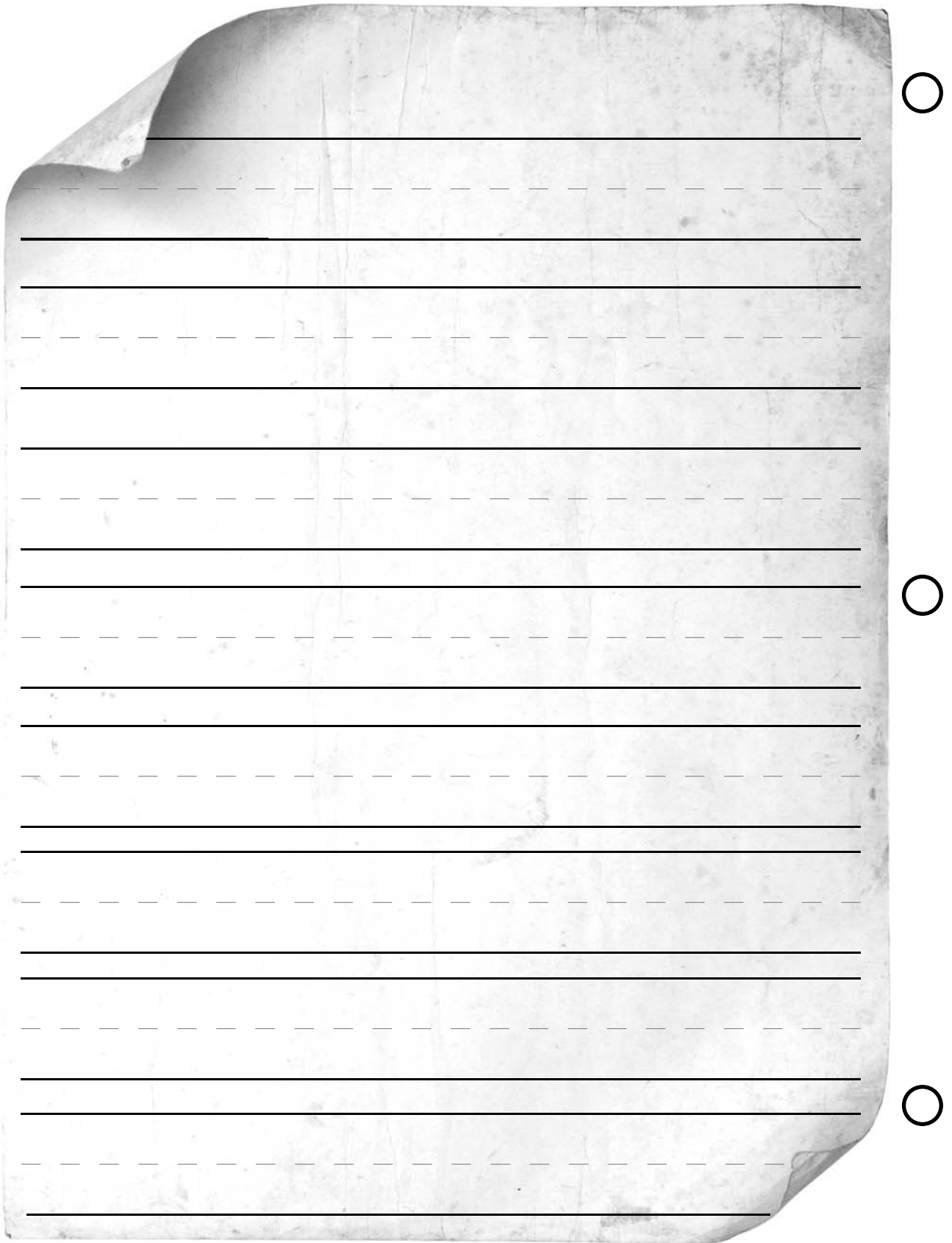



Dear Family Member,

Over the next several days, your child will learn more about the expedition of Lewis and Clark and the Corps of Discovery. S/he will also learn about a Native American, Sacagawea (sa-KA-ja-WE-uh), who helped the Corps as a guide.

### 1. Draw and Write

Your child will learn that Lewis and Clark kept journals to draw and write down the new plants and animals they saw on the expedition. Have your child draw and/or write about a plant or animal that fascinates—or interests—them on the journal page provided with this letter.

### 2. Where Are We?

On the map, have your child trace the route Lewis and Clark took to reach the Pacific Ocean.

### 3. Song: “America, the Beautiful”

Your child will learn the song, “America, the Beautiful.”

*O beautiful for spacious skies,  
For amber waves of grain,  
For purple mountain majesties  
Above the fruited plain!*

*America! America!  
God shed His grace on thee,  
And crown thy good with brotherhood  
From sea to shining sea!*

### 4. Sayings and Phrases: If at First You Don’t Succeed, Try, Try Again

Your child will learn the saying “If at first you don’t succeed, try, try again.” Talk with your child about the meaning of this saying and that if s/he doesn’t succeed the first time s/he tries something, s/he shouldn’t give up, but keep trying until s/he does succeed.

Be sure to let your child know how much you enjoy hearing about what s/he has been learning at school.



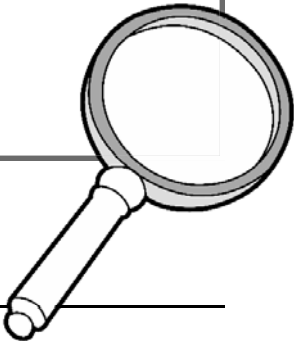

Four sets of horizontal writing lines. Each set consists of a solid top line, a dashed middle line, and a solid bottom line, providing a guide for handwriting practice.









### Vocabulary List for Frontier Explorers (Part 2)

This list includes many important words your child will learn about in *Frontier Explorers*. Try to use these words with your child in English and in your native language. Next to this list are suggestions of fun ways your child can practice and use these words at home.

- co-captain
- diary
- expedition
- honored
- prairie
- protection
- skilled
- translate
- journals
- record
- dull
- sign language
- waterfall
- canyons
- contentment

*Directions: Help your child pick a word from the vocabulary list. Then help your child choose an activity and do the activity with the word. Check off the box for the word. Try to practice a word a day in English and in your native language.*

	<b>Draw it</b>
	<b>Use it in a sentence</b>
	<b>Find one or two examples</b>
	<b>Tell a friend about it</b>
	<b>Act it out</b>
	<b>Make up a song using it</b>



### Join the Corps of Discovery!

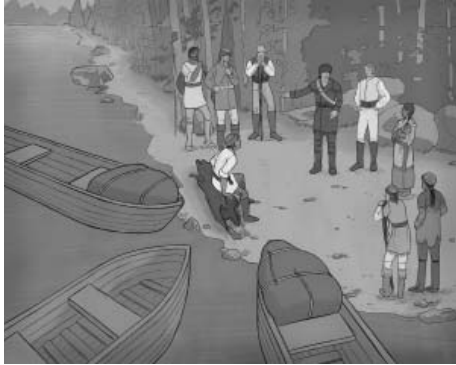

Are you \_\_\_\_\_  
-----  
\_\_\_\_\_

----- ?  
\_\_\_\_\_

Are you \_\_\_\_\_  
-----  
\_\_\_\_\_

----- ?  
\_\_\_\_\_

Do you \_\_\_\_\_  
-----  
\_\_\_\_\_

----- ?  
\_\_\_\_\_

Do you \_\_\_\_\_  
-----  
\_\_\_\_\_

----- ?  
\_\_\_\_\_



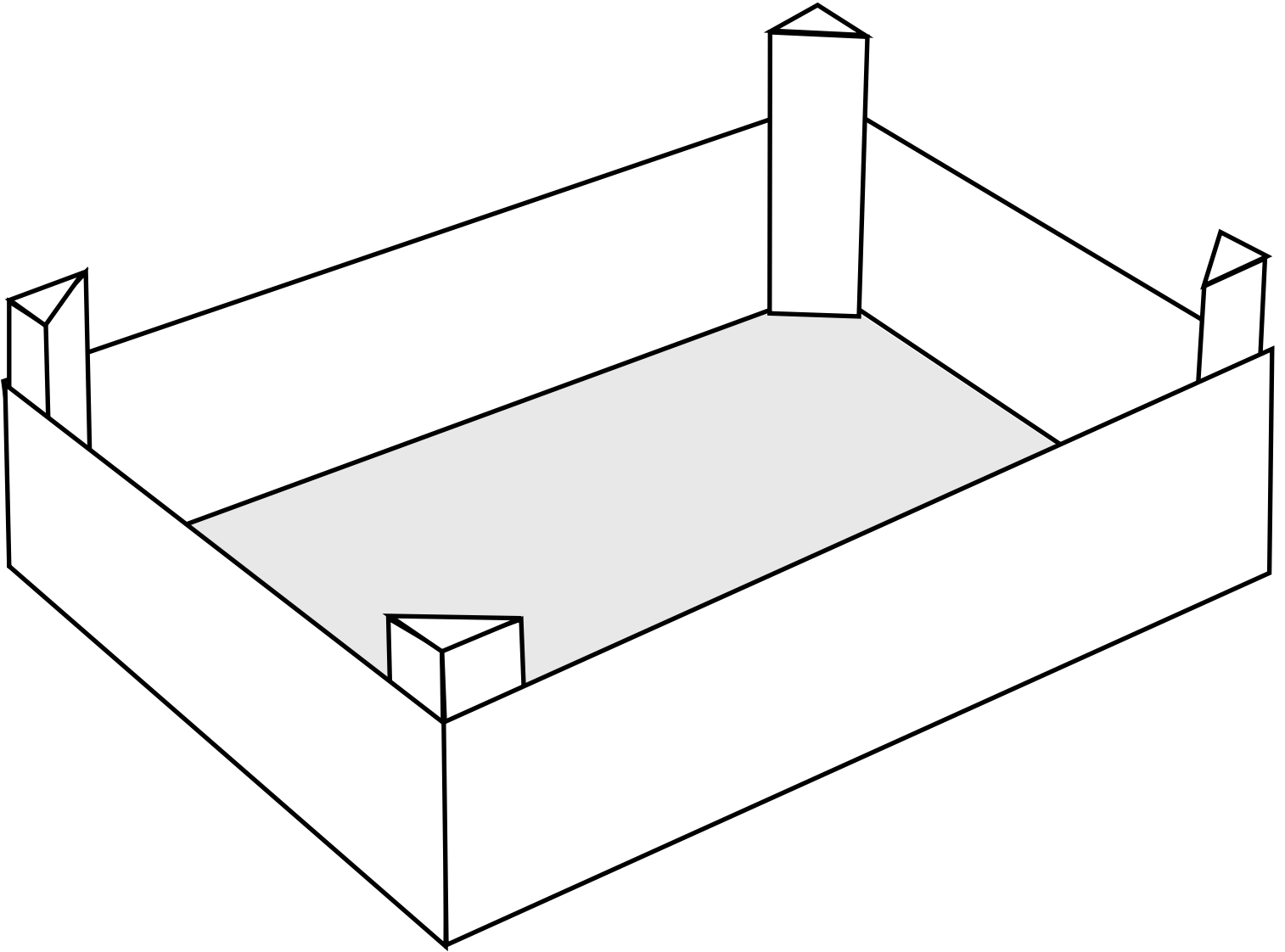

\_\_\_\_\_

-----

\_\_\_\_\_

-----

\_\_\_\_\_





May 14, 1804

Dear Diary,

Handwriting practice lines consisting of solid top and bottom lines with a dashed midline, repeated multiple times for writing.



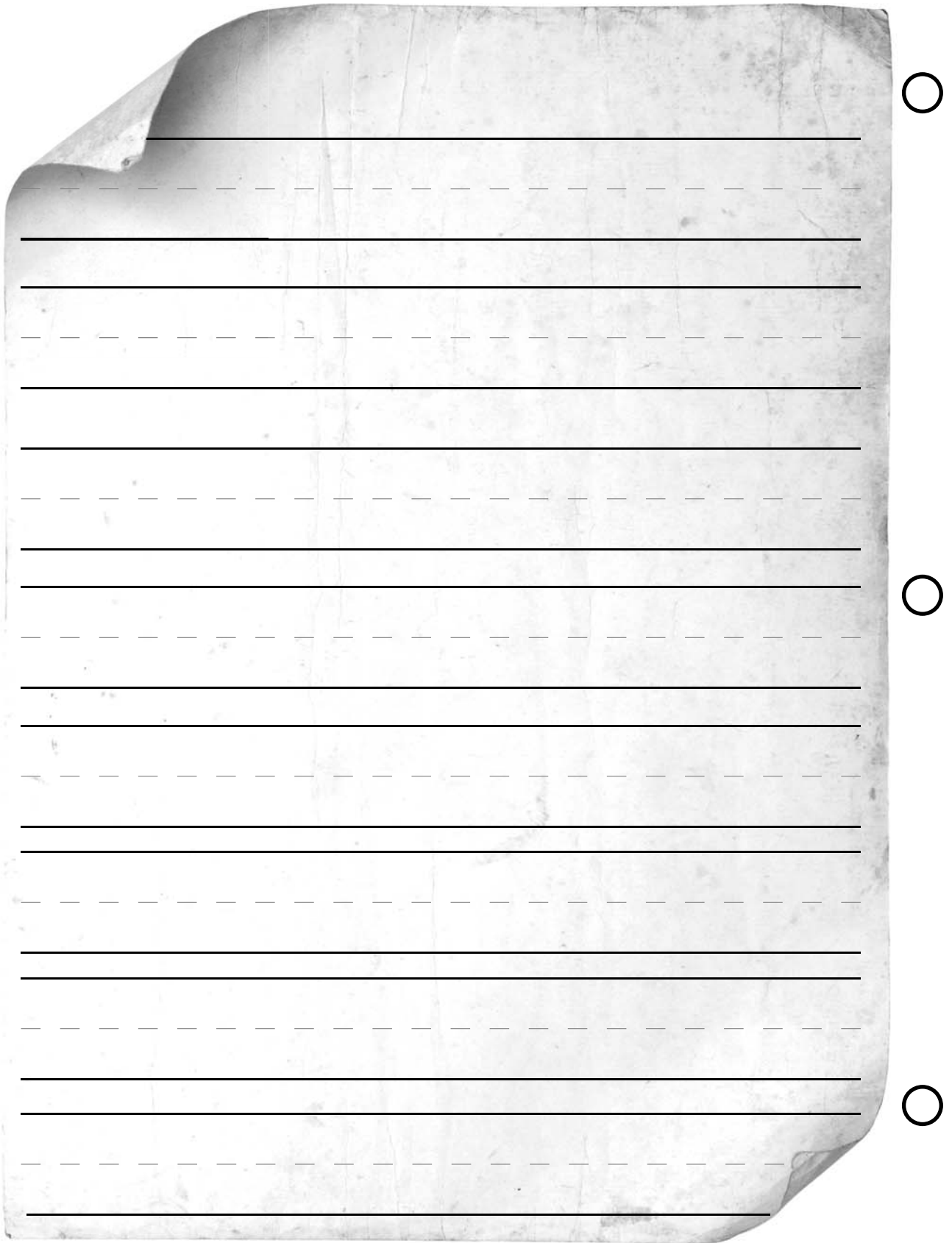



○

September \_\_\_\_, 1804



○

Handwriting practice lines consisting of solid top and bottom lines with a dashed middle line. There are three sets of these lines.

○

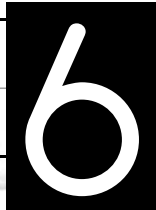

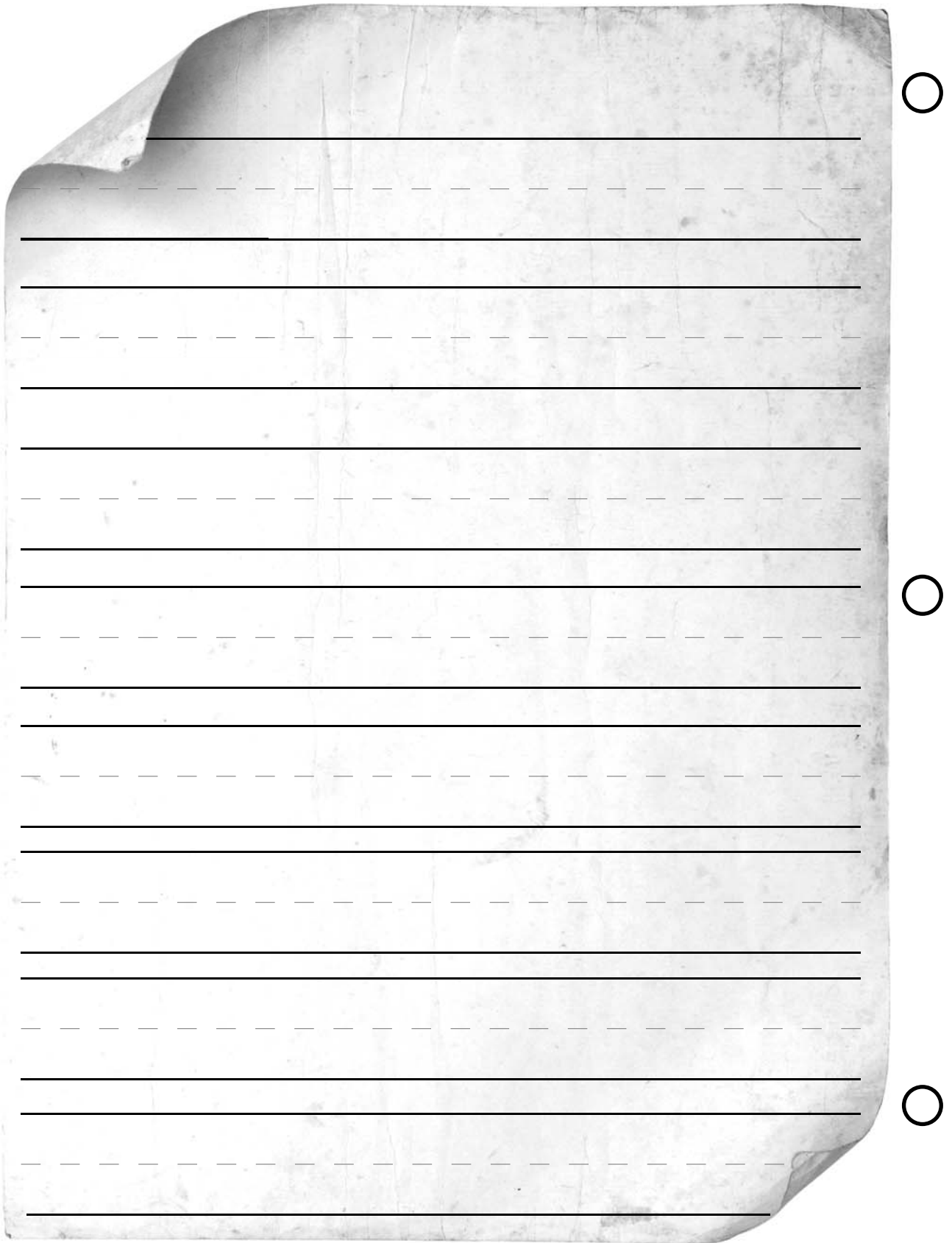

Name \_\_\_\_\_



Four sets of handwriting practice lines. Each set consists of a solid top line, a dashed middle line, and a solid bottom line.



\_\_\_\_\_

\_\_\_\_\_

\_\_\_\_\_

\_\_\_\_\_

\_\_\_\_\_

\_\_\_\_\_

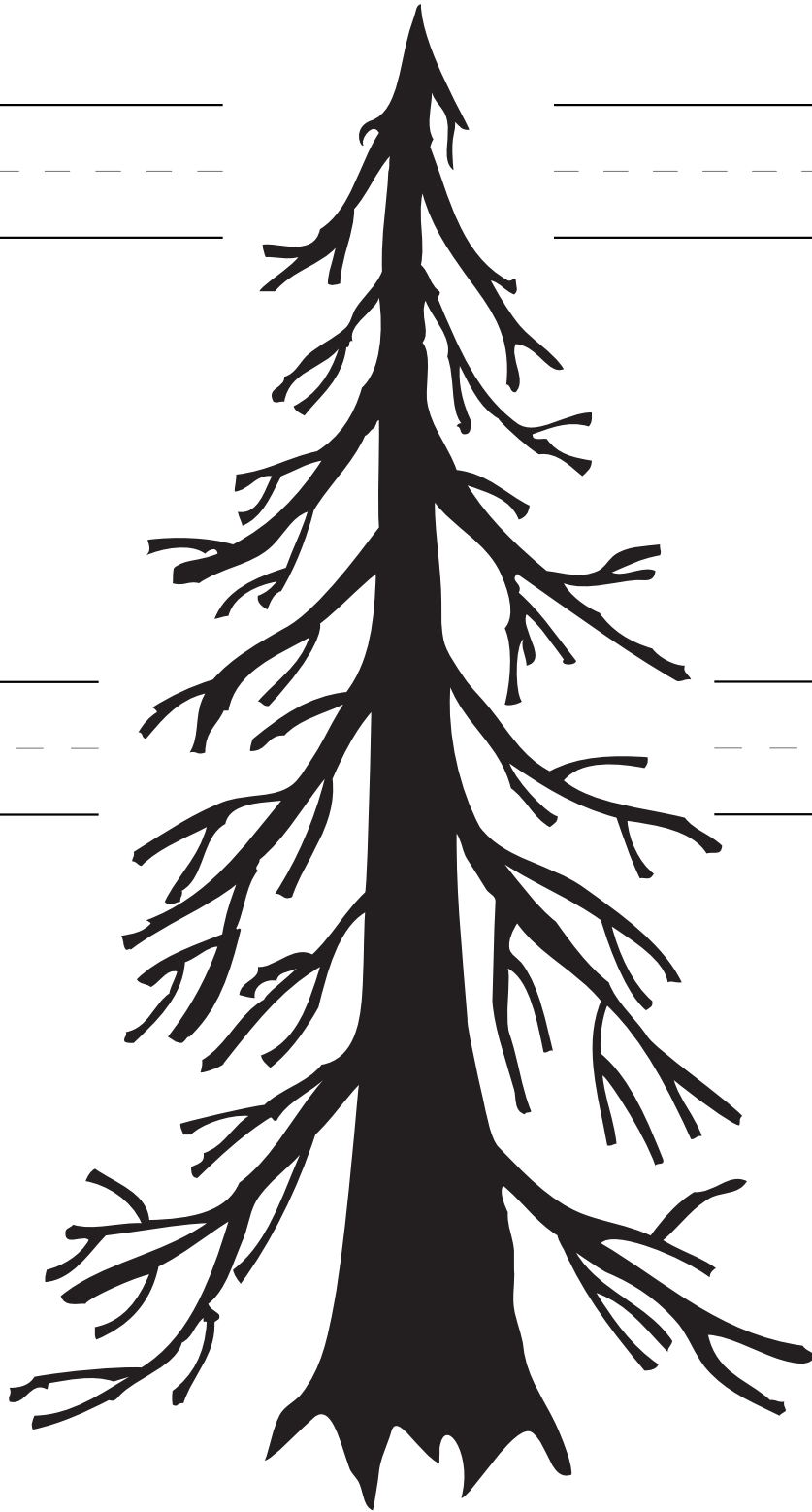



Name \_\_\_\_\_

---

---

---

---

---

---



---

---

---

---

---

---





○

April 29, 1805



○

Handwriting practice lines consisting of three sets of solid top and bottom lines with a dashed midline.

○

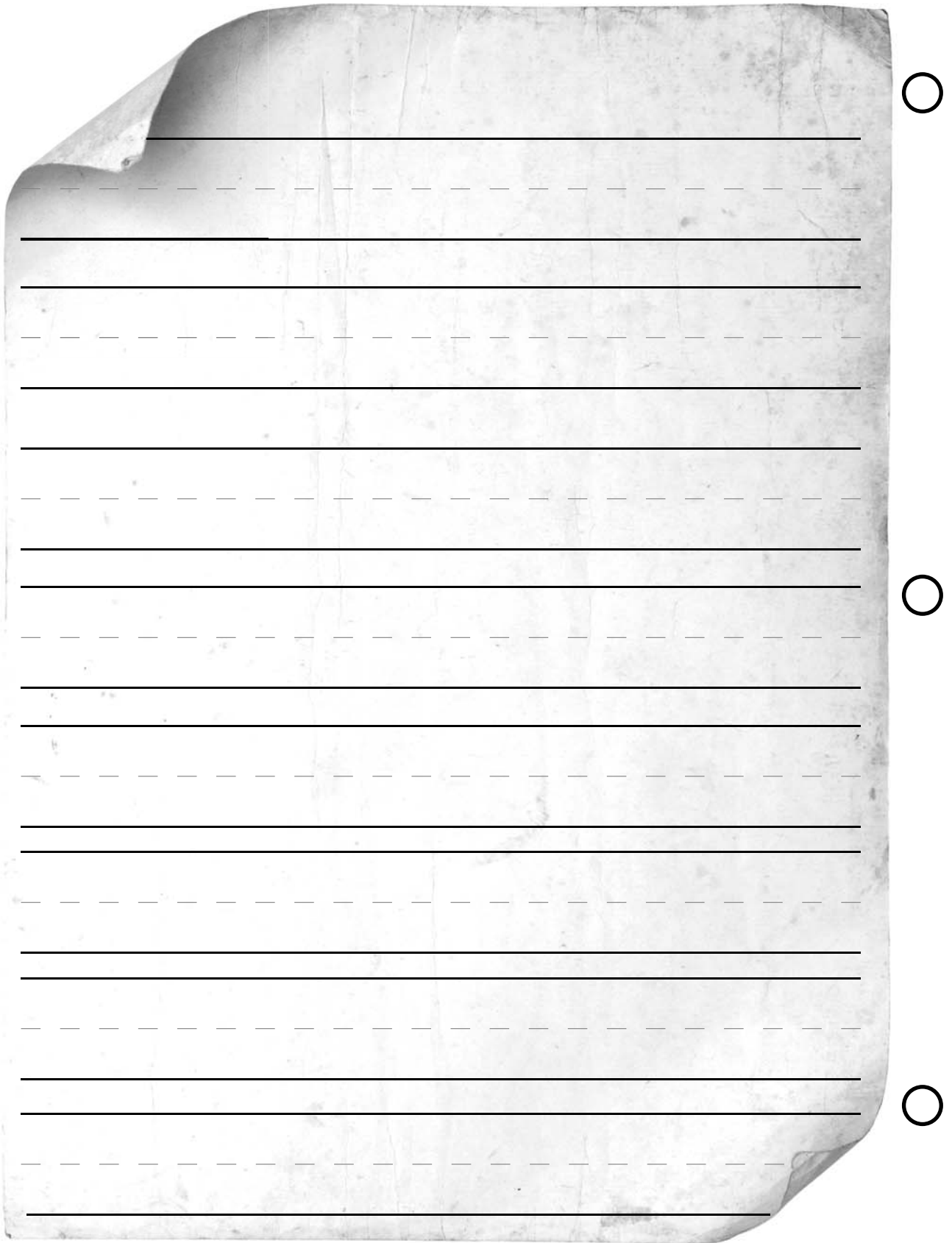

○

September 23, 1806



○

\_\_\_\_\_

-----

\_\_\_\_\_

-----

\_\_\_\_\_

-----

\_\_\_\_\_

○

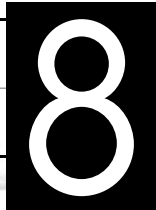

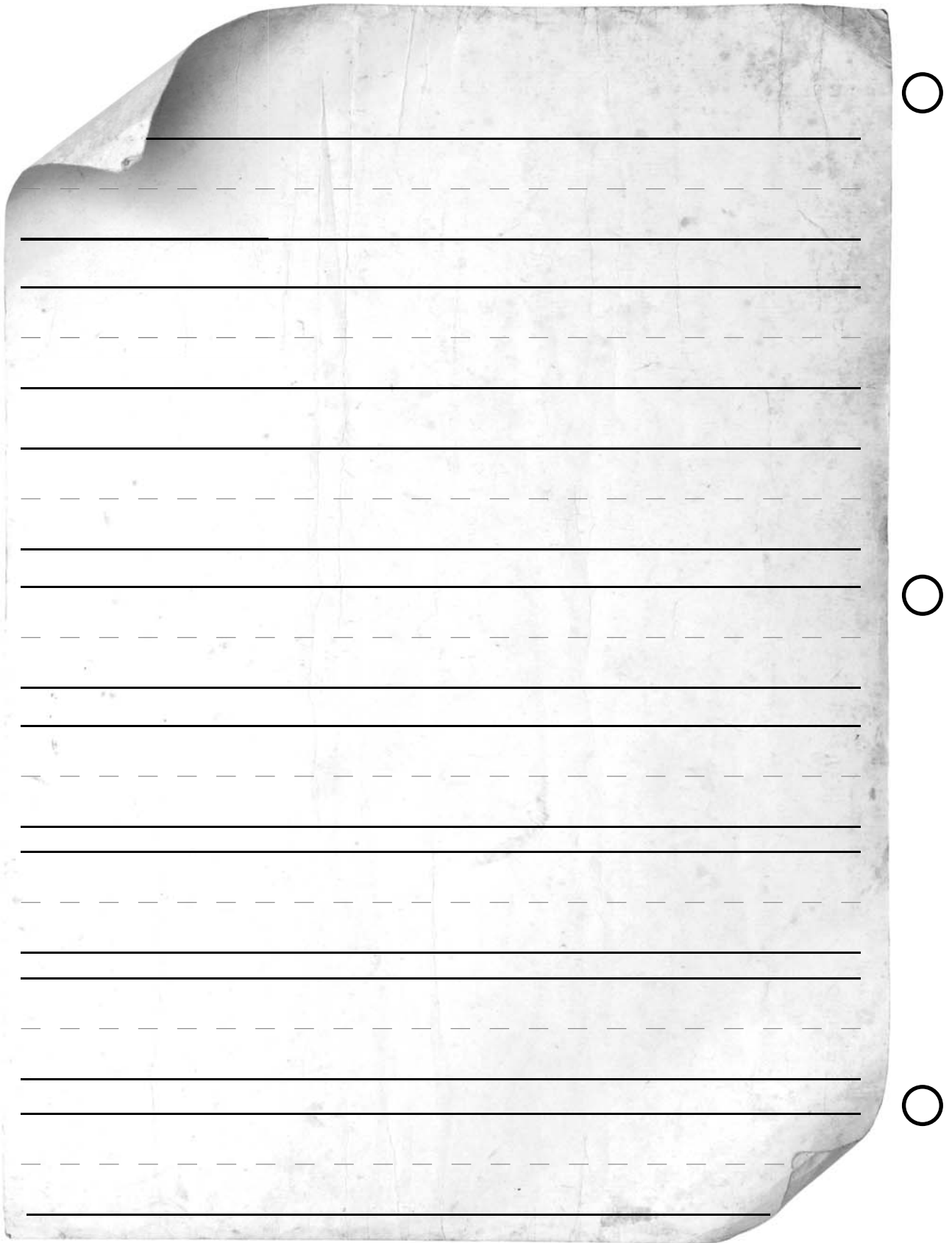

## America, the Beautiful

Written by Catherine Lee Bates

Composed by Samuel A. Ward

*O beautiful for spacious skies,  
For amber waves of grain,  
For purple mountain majesties  
Above the fruited plain!*























*America! America!  
God shed His grace on thee,  
And crown thy good with brotherhood  
From sea to shining sea!*





Directions: Listen carefully to the words and sentences read by your teacher. If the sentence uses the word correctly, circle the smiling face. If the sentence does not use the word correctly, circle the frowning face.

1.  
2.  
3.  
4.  
5.  
6.  
7.  
8.  
9.  
10.  

11. 



12. 



13. 



14. 



























15. 





Directions: Listen carefully to the words and sentences read by your teacher. If the sentence uses the word correctly, circle the smiling face. If the sentence does not use the word correctly, circle the frowning face.

1.		
2.		
3.		
4.		
5.		
6.		
7.		
8.		
9.		
10.		

11.  
12.  
13.  
14.  
15.  

Directions: Listen to the teacher's sentences. Circle the picture of the person or people the sentence is about.

1.



Daniel Boone



Thomas Jefferson



Lewis and Clark



Sacagawea

2.



Daniel Boone



Thomas Jefferson



Lewis and Clark



Sacagawea

3.



Daniel Boone



Thomas Jefferson



Lewis and Clark



Sacagawea

4.



Daniel Boone



Thomas Jefferson



Lewis and Clark



Sacagawea

5.



Daniel Boone



Thomas Jefferson



Lewis and Clark



Sacagawea

6.



Daniel Boone



Thomas Jefferson



Lewis and Clark



Sacagawea

7.



Daniel Boone



Thomas Jefferson



Lewis and Clark



Sacagawea

8.



Daniel Boone



Thomas Jefferson



Lewis and Clark



Sacagawea

9.



Daniel Boone



Thomas Jefferson



Lewis and Clark



Sacagawea

10.



Daniel Boone



Thomas Jefferson



Lewis and Clark



Sacagawea

Directions: Listen to the teacher's sentences. Circle the picture of the person or people the sentence is about.

1.



Daniel Boone



Thomas Jefferson



Lewis and Clark



Sacagawea

2.



Daniel Boone



Thomas Jefferson



Lewis and Clark



Sacagawea

3.



Daniel Boone



Thomas Jefferson



Lewis and Clark



Sacagawea

4.



Daniel Boone



Thomas Jefferson



Lewis and Clark



Sacagawea

5.



Daniel Boone



Thomas Jefferson



Lewis and Clark



Sacagawea

6.



Daniel Boone



Thomas Jefferson



Lewis and Clark



Sacagawea

7.



Daniel Boone



Thomas Jefferson



Lewis and Clark



Sacagawea

8.



Daniel Boone



Thomas Jefferson



Lewis and Clark



Sacagawea

9.



Daniel Boone



Thomas Jefferson



Lewis and Clark



Sacagawea

10.



Daniel Boone



Thomas Jefferson

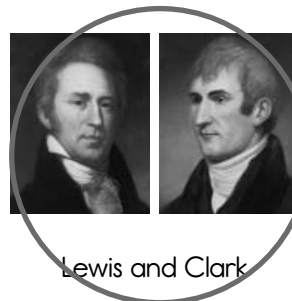

Lewis and Clark



Sacagawea

*Directions: Look at your map. First, find the Appalachian Mountains, and color them brown. Next, find the Mississippi River and color it blue. Find the Missouri River and color it red. Then, find the Rocky Mountains, and color them yellow. Last, find the area or territory that represents the Louisiana Purchase, and color it green.*

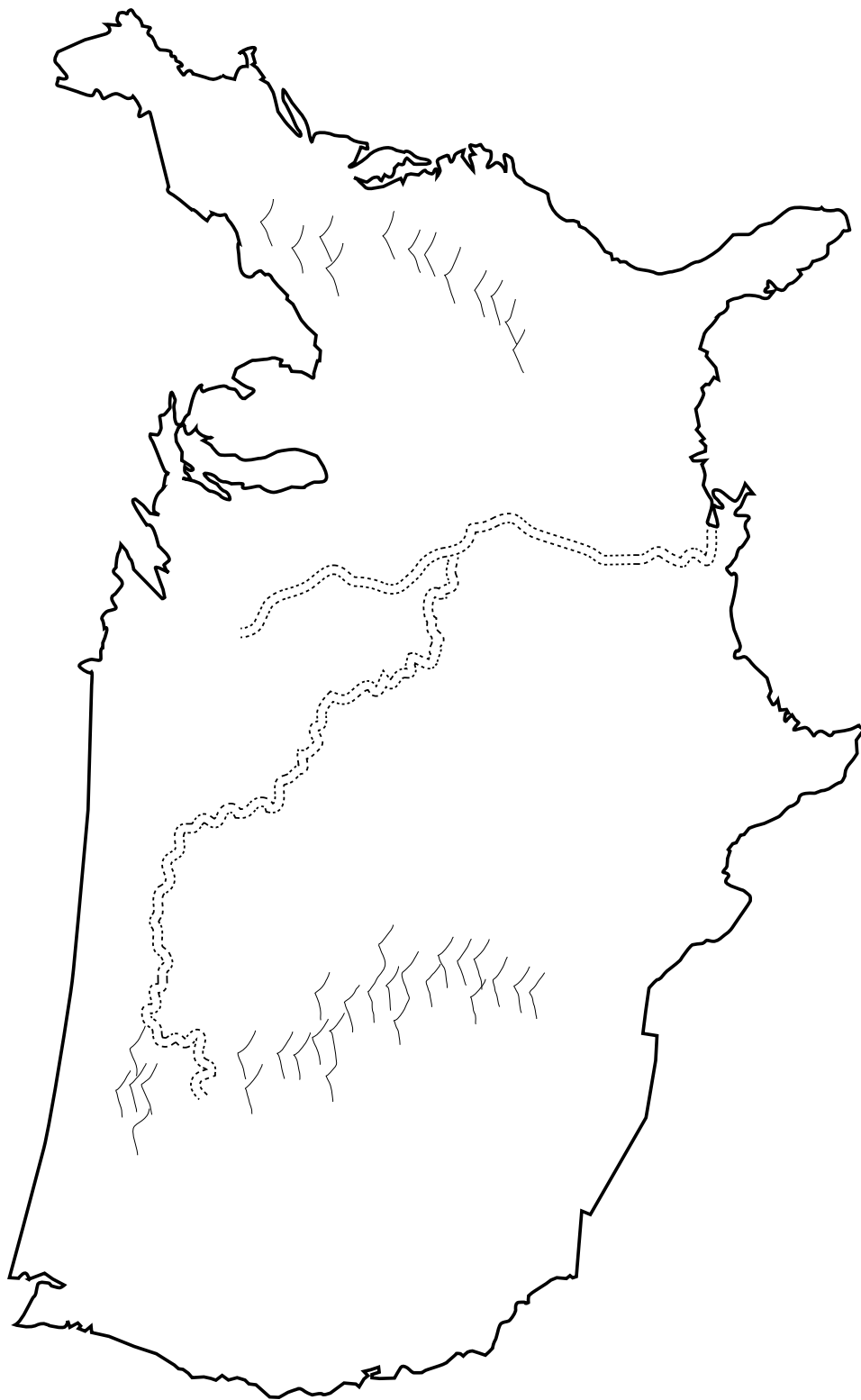







## Explorer's Journal

Name \_\_\_\_\_

This journal is about

\_\_\_\_\_

\_\_\_\_\_

\_\_\_\_\_

\_\_\_\_\_

\_\_\_\_\_



# Tens Recording Chart

Use this grid to record Tens scores. Refer to the Tens Conversion Chart that follows.

Name							

# Tens Conversion Chart

## Number Correct

	0	1	2	3	4	5	6	7	8	9	10	11	12	13	14	15	16	17	18	19	20
1	0	10																			
2	0	5	10																		
3	0	3	7	10																	
4	0	3	5	8	10																
5	0	2	4	6	8	10															
6	0	2	3	5	7	8	10														
7	0	1	3	4	6	7	9	10													
8	0	1	3	4	5	6	8	9	10												
9	0	1	2	3	4	6	7	8	9	10											
10	0	1	2	3	4	5	6	7	8	9	10										
11	0	1	2	3	4	5	5	6	7	8	9	10									
12	0	1	2	3	3	4	5	6	7	8	8	9	10								
13	0	1	2	2	3	4	5	5	6	7	8	8	9	10							
14	0	1	1	2	3	4	4	5	6	6	7	8	9	9	10						
15	0	1	1	2	3	3	4	5	5	6	7	7	8	9	9	10					
16	0	1	1	2	3	3	4	4	5	6	6	7	8	8	9	9	10				
17	0	1	1	2	2	3	4	4	5	6	6	7	7	8	8	9	9	10			
18	0	1	1	2	2	3	3	4	4	5	6	6	7	7	8	8	9	9	10		
19	0	1	1	2	2	3	3	4	4	5	5	6	6	7	7	8	8	9	9	10	
20	0	1	1	2	2	3	3	4	4	5	5	6	6	7	7	8	8	9	9	10	10

Simply find the number of correct answers the student produced along the top of the chart and the number of total questions on the worksheet or activity along the left side. Then find the cell where the column and the row converge. This indicates the Tens score. By using the Tens Conversion Chart, you can easily convert any raw score, from 0 to 20, into a Tens score.

Please note that the Tens Conversion Chart was created to be used with assessments that have a defined number of items (such as written assessments). However, teachers are encouraged to use the Tens system to record informal observations as well. Observational Tens scores are based on your observations during class. It is suggested that you use the following basic rubric for recording observational Tens scores.

9–10	Student appears to have excellent understanding
7–8	Student appears to have good understanding
5–6	Student appears to have basic understanding
3–4	Student appears to be having difficulty understanding
1–2	Student appears to be having great difficulty understanding
0	Student appears to have no understanding/does not participate

# CORE KNOWLEDGE LANGUAGE ARTS

## SERIES EDITOR-IN-CHIEF

E. D. Hirsch, Jr.

## PRESIDENT

Linda Bevilacqua

### EDITORIAL STAFF

Carolyn Gosse, Senior Editor - Preschool  
Khara Turnbull, Materials Development Manager  
Michelle L. Warner, Senior Editor - Listening & Learning

Mick Anderson  
Robin Blackshire  
Maggie Buchanan  
Paula Coyner  
Sue Fulton  
Sara Hunt  
Erin Kist  
Robin Luecke  
Rosie McCormick  
Cynthia Peng  
Liz Pettit  
Ellen Sadler  
Deborah Samley  
Diane Auger Smith  
Sarah Zelinke

### DESIGN AND GRAPHICS STAFF

Scott Ritchie, Creative Director

Kim Berrall  
Michael Donegan  
Liza Greene  
Matt Leech  
Bridget Moriarty  
Lauren Pack

### CONSULTING PROJECT MANAGEMENT SERVICES

ScribeConcepts.com

### ADDITIONAL CONSULTING SERVICES

Ang Blanchette  
Dorrit Green  
Carolyn Pinkerton

## ACKNOWLEDGMENTS

These materials are the result of the work, advice, and encouragement of numerous individuals over many years. Some of those singled out here already know the depth of our gratitude; others may be surprised to find themselves thanked publicly for help they gave quietly and generously for the sake of the enterprise alone. To helpers named and unnamed we are deeply grateful.

### CONTRIBUTORS TO EARLIER VERSIONS OF THESE MATERIALS

Susan B. Albaugh, Kazuko Ashizawa, Nancy Braier, Kathryn M. Cummings, Michelle De Groot, Diana Espinal, Mary E. Forbes, Michael L. Ford, Ted Hirsch, Danielle Knecht, James K. Lee, Diane Henry Leipzig, Martha G. Mack, Liana Mahoney, Isabel McLean, Steve Morrison, Juliane K. Munson, Elizabeth B. Rasmussen, Laura Tortorelli, Rachael L. Shaw, Sivan B. Sherman, Miriam E. Vidaver, Catherine S. Whittington, Jeannette A. Williams

We would like to extend special recognition to Program Directors Matthew Davis and Souzanne Wright who were instrumental to the early development of this program.

### SCHOOLS

We are truly grateful to the teachers, students, and administrators of the following schools for their willingness to field test these materials and for their invaluable advice: Capitol View Elementary, Challenge Foundation Academy (IN), Community Academy Public Charter School, Lake Lure Classical Academy, Lepanto Elementary School, New Holland Core Knowledge Academy, Paramount School of Excellence, Pioneer Challenge Foundation Academy, New York City PS 26R (The Carteret School), PS 30X (Wilton School), PS 50X (Clara Barton School), PS 96Q, PS 102X (Joseph O. Loretan), PS 104Q (The Bays Water), PS 214K (Michael Friedsam), PS 223Q (Lyndon B. Johnson School), PS 308K (Clara Cardwell), PS 333Q (Goldie Maple Academy), Sequoyah Elementary School, South Shore Charter Public School, Spartanburg Charter School, Steed Elementary School, Thomas Jefferson Classical Academy, Three Oaks Elementary, West Manor Elementary.

And a special thanks to the CKLA Pilot Coordinators Anita Henderson, Yasmin Lugo-Hernandez, and Susan Smith, whose suggestions and day-to-day support to teachers using these materials in their classrooms was critical.



## CREDITS

Every effort has been taken to trace and acknowledge copyrights. The editors tender their apologies for any accidental infringement where copyright has proved untraceable. They would be pleased to insert the appropriate acknowledgment in any subsequent edition of this publication. Trademarks and trade names are shown in this publication for illustrative purposes only and are the property of their respective owners. The references to trademarks and trade names given herein do not affect their validity.

The Word Work exercises are based on the work of Beck, McKeown, and Kucan in *Bringing Words to Life* (The Guilford Press, 2002).

All photographs are used under license from Shutterstock, Inc. unless otherwise noted.

## EXPERT REVIEWER

Craig Thompson Friend; Jeffrey Hantman

## WRITERS

Linda Bevilacqua; Anne Marie Pace; Catherine S. Whittington;  
James Weiss

## ILLUSTRATORS AND IMAGE SOURCES

Cover: Steve Morrison; Title Page: Steve Morrison; Domain Icon: Shutterstock; Take Home icon: Core Knowledge Staff; 1A-1: Shutterstock; 1A-2: Library of Congress, Prints & Photographs Division, LC-DIG-ggbain-30546; 1A-3: Scott Hammond; 1A-4: Shutterstock; 1A-5: Shari Griffiths; 1A-6: Shutterstock; 1A-7: Shutterstock; 1A-8: Shutterstock; 1A-9: Shutterstock; 2A-1: Kristin Kwan; 2A-2: Kristin Kwan; 2A-3: Kristin Kwan; 2A-4: Kristin Kwan; 2A-5: Kristin Kwan; 2A-6: Kristin Kwan; 2A-7: Library of Congress, Prints & Photographs Division, LC-DIG-ggbain-16010; 2A-8: Library of Congress, Prints & Photographs Division, LC-DIG-ggbain-33962; 2A-9: By Brown Brothers, ca. 1908, Records of the Public Health Service (90-G-125-29), NARA; 3A-1: Kristin Kwan; 3A-2: Kristin Kwan; 3A-3: Kristin Kwan; 3A-4: Kristin Kwan; 3A-5: Library of Congress, Prints & Photographs Division, LC-DIG-ggbain-30546; 3A-6 (top left): Library of Congress, Prints & Photographs Division, Arnold Genthe Collection: Negatives and Transparencies, LC-USZC4-6893; 3A-6 (top middle): Library of Congress, Prints and Photographs, LC-USZ62-97491; 3A-6 (top right): Library of Congress, Prints and Photographs, LC-USZ62-111750; 3A-6 (bottom): Library of Congress, Prints and Photographs, LC-DIG-ds-03059; 3A-7 (top): Library of Congress, Prints and Photographs Division, National Child Labor Committee Collection, LC-DIG-nclc-04455; 3A-7 (bottom): Library of Congress, Prints and Photographs Division, National Child Labor Committee Collection, LC-DIG-nclc-04455; 3A-8: Library of Congress, Prints and Photographs Division, Detroit Publishing Company Collection, LC-DIG-det-4a28391; 3A-9: Library of Congress, Prints and Photographs Division, Arnold Genthe Collection: Negatives and Transparencies, LC-G403-BN-0250-B; 4A-1: Shutterstock; 4A-2: Kristin Kwan; 4A-3: Kristin Kwan; 4A-4: Kristin Kwan; 4A-5: Kristin Kwan; 4A-6: Kristin Kwan; 4A-7: Kristin Kwan; 5A-1: Jed Henry; 5A-2: Jed Henry; 5A-3: Jed Henry; 5A-4: Jed Henry; 5A-5: Jed Henry; 5A-6: Jed Henry; 5A-7: Jed Henry; 5A-8: Jed Henry; 5A-9: Jed Henry; 6A-1: Scott Hammond; 6A-2: public domain; 6A-3: Library of Congress, Prints & Photographs Division, LC-DIG-ppmsca-19191; 6A-4: Scott Hammond; 6A-5: Scott Hammond; 6A-6: Scott Hammond; 6A-7: Scott Hammond; 7A-1 (top left): Library of Congress, Prints and Photographs, LC-USZ62-20622; 7A-1 (top middle): Library of Congress, Prints and Photographs, LC-USZ62-97491; 7A-1 (top right): Library of Congress, Prints and Photographs, LC-USZ62-97491; 7A-1 (bottom left): Library of Congress, Prints and Photographs, LC-USZ62-23711; 7A-1 (bottom middle): Library of Congress, Prints & Photographs Division, LC-DIG-ggbain-22287; 7A-1 (bottom right): Library of Congress, Prints and Photographs, LC-USZ62-26617; 7A-2: Shutterstock; 7A-3: Core Knowledge Staff; 7A-4: Library of Congress, Prints and Photographs, LC-DIG-pga-03473; 7A-5: Library of Congress, Prints & Photographs Division, National Child Labor Committee Collection, LC-DIG-nclc-05054; 7A-6: Library of Congress, Prints & Photographs Division, Arnold Genthe Collection: Negatives and Transparencies, LC-USZC4-6893; 7A-7: Core Knowledge Staff;

7A-8: Shutterstock; 7A-9: Shutterstock; 7A-10: Shutterstock; 7A-11: Shutterstock; 7A-12: Shutterstock; 8A-1: Shutterstock; 8A-2: Shutterstock; 8A-3: Shutterstock; 8A-4: Shari Griffiths; 8A-5: Shari Griffiths; 8A-6: Shari Griffiths; 8A-7: Shari Griffiths; 8A-8: Shari Griffiths; 8A-9: Shari Griffiths; 8A-10: Shari Griffiths; 9A-1: Shutterstock; 9A-2: public domain; 9A-3: Library of Congress, Prints and Photographs, LC-H8-CT-C01-062; 9A-4: Scott Hammond; 9A-5: Library of Congress, Prints and Photographs Division, LC-USZ62-16960; 9A-6: Shutterstock; 9A-7: Shutterstock; 9A-8: Library of Congress, Prints and Photographs, LC-H8-CT-C01-062; 10A-1 (left): Tyler Pack; 10A-1 (middle): Scott Hammond; 10A-1 (right): Scott Hammond; 10A-2 (left): public domain; 10A-2 (middle): public domain; 10A-2 (right): public domain; 10A-3: Shutterstock; 10A-4: public domain; 10A-5: Shutterstock; 10A-6: Shutterstock; 10A-7: Shutterstock; 10A-8: Shutterstock; 10A-9: Shutterstock; 10A-10: Shutterstock; 10A-11: Shutterstock; 1A-1: Shutterstock; 1A-1 (Answer Key): Shutterstock; 1B-1: Shutterstock; 1B-1 (push): Core Knowledge Staff; 1B-1 (pull): Core Knowledge Staff; 1B-1 (bird/worm): Core Knowledge Staff; 1B-2: Core Knowledge Staff; 1B-3 (pilgrims): Scott Hammond; 1B-3 (Steinmetz, left): Kristin Kwan; 1B-3 (Steinmetz, right): Kristin Kwan; 1B-3 (Sean & Fiona): Kristin Kwan; 1B-3 (Lin Wen): Jed Henry; 1B-3 (poor in China): Library of Congress, Prints and Photographs Division, Arnold Genthe Collection: Negatives and Transparencies, LC-G403-BN-0250-B; 1B-3 (Lars & Karin, Sweden): public domain; 1B-3 (Lars & Karin, America): Scott Hammond; 1B-3: Shutterstock; 1B-3 Answer Key (pilgrims): Scott Hammond; 1B-3 Answer Key (Steinmetz, left): Kristin Kwan; 1B-3 Answer Key (Steinmetz, right): Kristin Kwan; 1B-3 Answer Key (Sean & Fiona): Kristin Kwan; 1B-3 Answer Key (Lin Wen): Jed Henry; 1B-3 Answer Key (poor in China): Library of Congress, Prints and Photographs Division, Arnold Genthe Collection: Negatives and Transparencies, LC-G403-BN-0250-B; 1B-3 Answer Key (Lars & Karin, Sweden): public domain; 1B-3 Answer Key (Lars & Karin, America): Scott Hammond; 1B-3 Answer Key: Shutterstock; 1B-5: Kristin Kwan; 1B-7: Shutterstock; 2B-1: Shutterstock; 3A-1: Shutterstock; 3A-1 (policyperson): Core Knowledge Staff; 3B-1: Shutterstock; 4B-1: Shutterstock; 5B-1: Shutterstock; 6B-1: Shutterstock; PP-1: Core Knowledge Staff; PP-1 Answer Key: Core Knowledge Staff; PP-2: Shutterstock; PP-2 (policyperson): Core Knowledge Staff; PP-2 Answer Key (policyperson): Core Knowledge Staff; 7B-3: Shutterstock; 7B-3 (flag): Core Knowledge Staff; 9B-1: Core Knowledge Staff; DA-2: Shutterstock; DA-2 (James Madison): public domain; DA-2 (colonists): Scott Hammond; DA-2 Answer Key: Shutterstock; DA-2 Answer Key (James Madison): public domain; DA-2 Answer Key (colonists): Scott Hammond

Regarding the Shutterstock items listed above, please note: "No person or entity shall falsely represent, expressly or by way of reasonable implication, that the content herein was created by that person or entity, or any person other than the copyright holder(s) of that content."





# Frontier Explorers

Tell It Again!™ Read-Aloud Supplemental Guide

Listening & Learning™ Strand  
**GRADE 1**

The Core Knowledge Foundation  
[www.coreknowledge.org](http://www.coreknowledge.org)