

# Appendix B Toys You Can Make

## Toys that help develop use of hands and sense of touch

You can make beads and chains out of wild fruits and nuts.

prickly



rough and smooth



fuzzy



wrinkled or lumpy



smooth



wriggly



For a baby, hang a ring of beads where she can reach and handle it.



A child can play putting the nuts and pods in and out of a container.

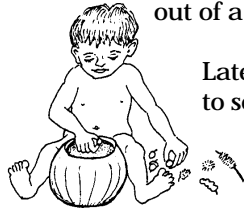

Later he can learn to sort them.

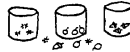

As the child develops more hand control, she can begin to make chains and necklaces by stringing beads on a cord.



'Snakes' can be made by stringing nuts, 'caps' of acorns, bottle caps, or any combination of things.

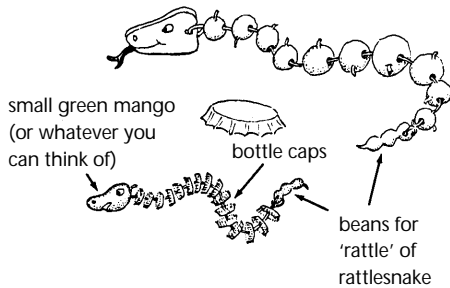

If you use your imagination, there are all kinds of toy animals you and your children can have fun making.

'Hedgehogs'

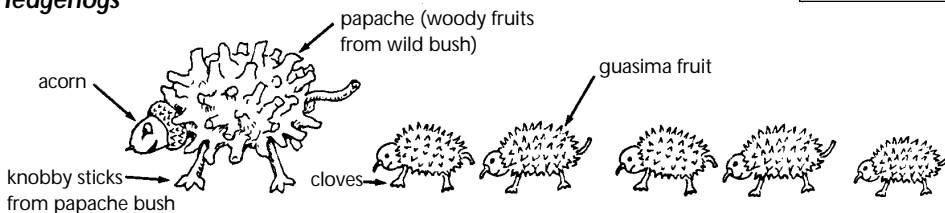

## Rattles and other noise toys

### Gourd rattle

Find a small gourd (wild gourds or tree gourds may work).



Cut a round hole at the stem and clean out the seeds and flesh. Let it dry out well.



Put 2 or 3 small rocks, nuts or other objects inside.



Find a stick the size of the hole. If the hole is large, thin down this part of the stick.



Glue the stick to the gourd.

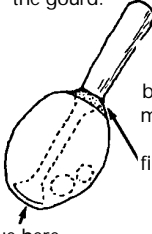

Glue here.

To make it stronger and better looking, mix white glue and sawdust, fill in here, and after the glue dries, sand it smooth.

Paint it colorfully.

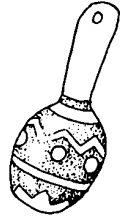

### Plastic bottle rattle

a see-through plastic bottle

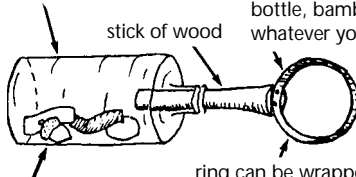

ring cut from a plastic bottle, bamboo or whatever you have

stick of wood

strips cut from plastic bottles of different colors, colorful stones, nuts, etc.

ring can be wrapped with strips of cloth or tire tubing for easier grip

### Bamboo rattle

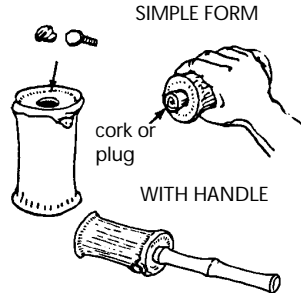

SIMPLE FORM

cork or plug

WITH HANDLE

### Tin can rattle

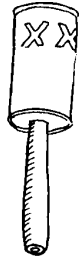

### Cowhorn rattle

Trim rough edges.



Put in a cardboard or wood plug.

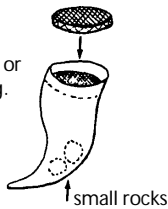

small rocks

Then seal with a mix of sawdust and white glue, or plaster of Paris.

glue  
sawdust

Smooth the surface and let it dry.

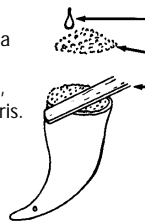

## Ideas for homemade music



gourds with seeds in them



2 wood sticks

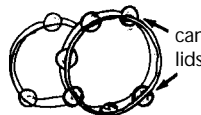

tambourine

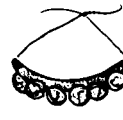

jingle bells



jingle bells

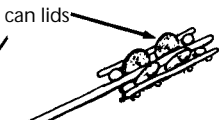

marimba

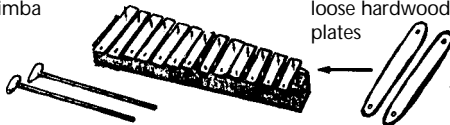

loose hardwood plates

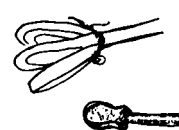

castanets (wooden clappers)

**Soft rattle**

Use a small can or bottle with a small stone inside...



...or use 2 small bells.



Cut a colorful soft cloth (flannel) into this shape.

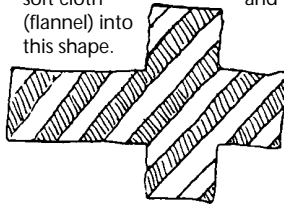

Sew it into a square and turn inside out.

Place can or bells in cloth square and pack wild kapok, cotton or bits of sponge around it. Sew it shut.

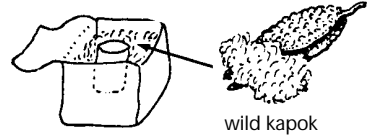

**Doll rattle**

Draw a doll on 2 pieces of cloth, and cut them out.

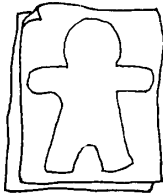

Sew the 2 dolls together.

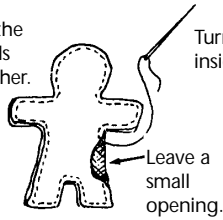

Turn the doll inside out.



Put small bells or a rattle inside and stuff with kapok, cotton or sponge and sew shut.

Sew or draw on a face.



**Animal rattles**

can be made in the same way.

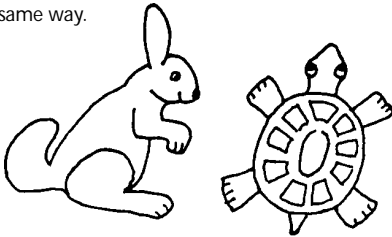

**Ball rattle**

Cut 3 pieces of one color...

...and 3 pieces of another color.

Sew them together except for a small hole. Turn inside out and stuff.

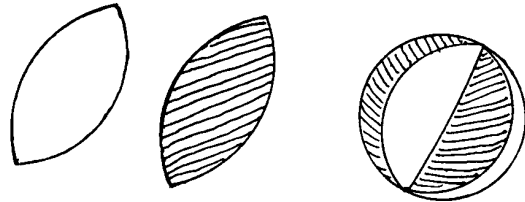

**Push-along noise toy**

Make hole in lid and bottom of tin.

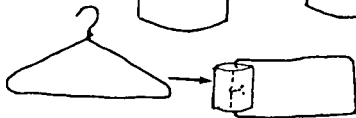
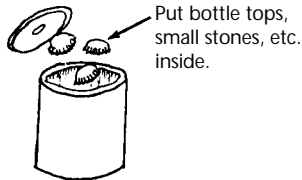

Put loop of stiff wire through holes with knot inside tin.



**Bamboo push-along**

Cut here

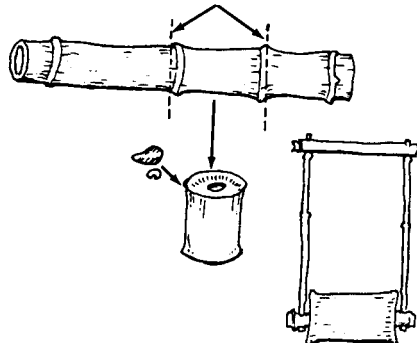

## Games fitting pegs or blocks into holes

These games help develop better hand control and 'hand-eye coordination.' They also help the child learn to compare sizes, shapes, and color.

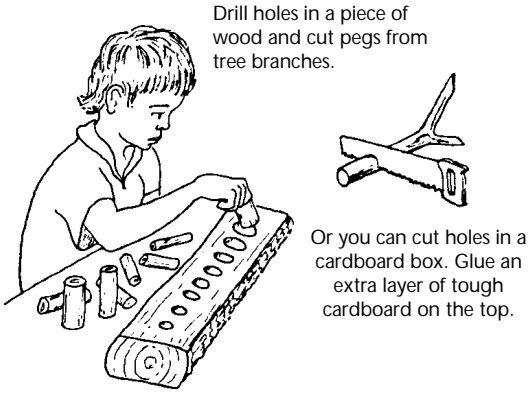

Or make a 'size box' by pouring cement, plaster of Paris, or clay into a mold. Or, make a 'plaster' box out of cow-dung or mud mixed with sand (and lime if you have it). Press pegs into the wet plaster, and remove when almost dry.

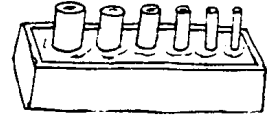

For pegs, use bottles, scraps of pipe, pieces of broom handles, bolts — or whatever you have.

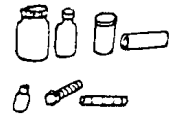

Also, make games that help the child develop a twisting motion in her hands and wrists.

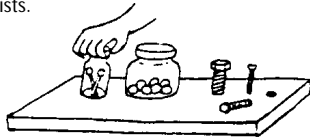

### Other ideas

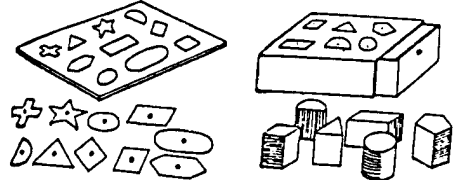

### Blocks for building a tower on pegs

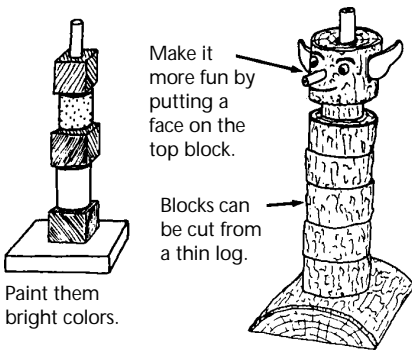

### Shapes on pegs

With these, children learn about matching colors, shapes, and sizes.

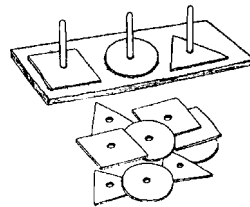

### Gourd Racing Car

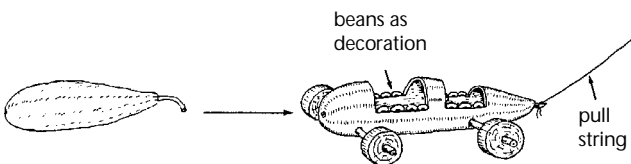

### Building blocks

